

MAILBOXES

COMMERCIAL • RESIDENTIAL



Manufacturing Since 1936!



The Industry Leader in Quality Mailboxes

Visit us at Mailboxes.com!

- Current pricing and product availability
- Volume discounts and promotions
- Web specials - discounted prices
- Secure online ordering 24 hours a day
- Company information & history
- Request a quote
- CBU and 4C mailbox configurators
- Augmented Reality (AR) models
- Download forms & information
- Technical drawings & product specifications
- Product installation instructions and videos
- 3D Revit / Building Information Modeling (BIM) models



Table of Contents

GENERAL INFORMATION

Manufacturing Quality Products Since 1936 4-5
Centralized Mail Delivery 6
Design Assistance 7

COMMERCIAL MAILBOXES

Cluster Box Units & Outdoor Parcel Lockers - Standard 8-11
Cluster Box Units & Outdoor Parcel Lockers - Regency® Decorative . . . 12-13
Cluster Box Units & Outdoor Parcel Lockers - Specifications and Options 14-15
4C Horizontal Mailboxes - Recessed Mounted 16-19
4C Horizontal Mailboxes - Surface Mounted 20-23
4C Horizontal Mailboxes - Free-Standing 24-27
4C Horizontal Mailboxes - Custom 28-29
4C Horizontal Mailboxes - Specifications & Options 30-31
4B+ Horizontal Mailboxes 32-33
Vertical Mailboxes 34-35
Aluminum Mailboxes - Standard System 36-37
Aluminum Mailboxes - Rack Ladder System 38-39
Letter Boxes 40-41
Mail Drops & Receptacles 42-43
Courier Boxes 44-45
Mail Package Drops 46-47
Mail Chests 48-49
Mailbox Locks & Key Blanks 50-51

RESIDENTIAL MAILBOXES & POSTS

Roadside Mailboxes 52-53
Heavy Duty Rural Mailboxes 54-55
Standard Mailbox Posts & Spreaders 56-57
Deluxe Mailbox Posts 58-59

CELL PHONE LOCKERS

Cell Phone Lockers 60-61
Cell Phone Locker Options & Locks 62

ADDITIONAL INFORMATION

Lockers - Metal, Wood and Plastic 63



Salsbury Industries provides commercial mailboxes for both U.S. Postal Service access and private access. The following symbols will assist you in selecting the appropriate products.



Choose products with this symbol when mailbox is to be accessed by the U.S. Postal Service. Complying with postal specifications, these products are designed to accept a master postal lock which is issued and installed by your local postal authorities.



Choose products with this symbol when mailbox is not to be accessed by the U.S. Postal Service. Manufactured with quality materials, these products are ideal for private postal centers, government agencies, corporate mailrooms, colleges and schools, banks, military bases and many other applications.

Manufacturing Quality Products Since 1936

Salsbury Industries has excelled in manufacturing and distributing quality products for nearly 100 years. Our vertically integrated manufacturing and distribution facilities and our ISO 9001: 2015 Quality Management System allow us to effectively and efficiently produce components that are carefully manufactured, assembled, inspected, packaged and shipped to our valued customers. Our products are shipped from our manufacturing facilities and distribution centers in Los Angeles and Carson, California. Whether you are around the corner or around the world, most orders ship from our large inventory within 1 to 2 business days of receipt.



Salsbury Industries maintains a recycling program for the reprocessing of our aluminum, s



600,000 Square Feet of M

Machinery & Capabilities

- ROBOTIC WELDING
- WATERJET CUTTING
- CNC MACHINES
- PUNCH PRESSES
- PRESS BRAKES
- TURRET PRESSES
- POWDER COATING
- STAMPING
- MILLING
- SHEARING
- SAWING
- ASSEMBLING
- PACKAGING
- SHIPPING



Large Inventory

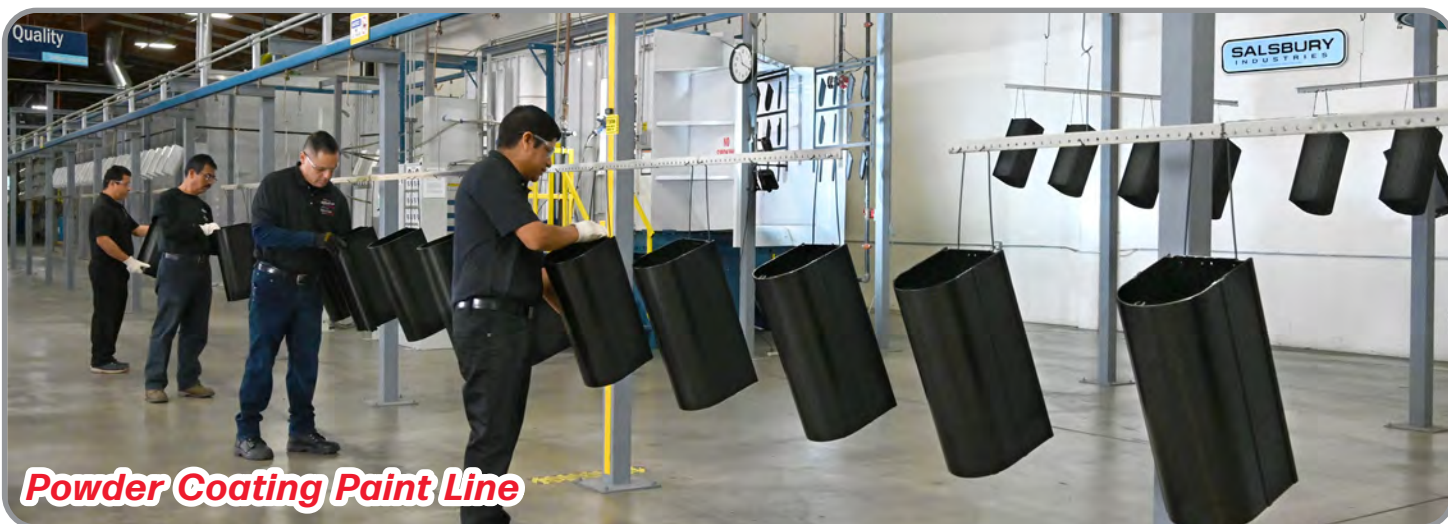

Powder Coating Paint Line

successful recycling program that ensures the proper reuse and steel, powder paint and corrugated materials.



Manufacturing and Distribution Facilities

Quality System

Salsbury Industries manufacturing facilities are ISO 9001: 2015 certified. ISO 9001: 2015 is an internationally recognized Quality Management System that requires a company to continually improve the effectiveness of its processes for the purposes of enhancing customer satisfaction.

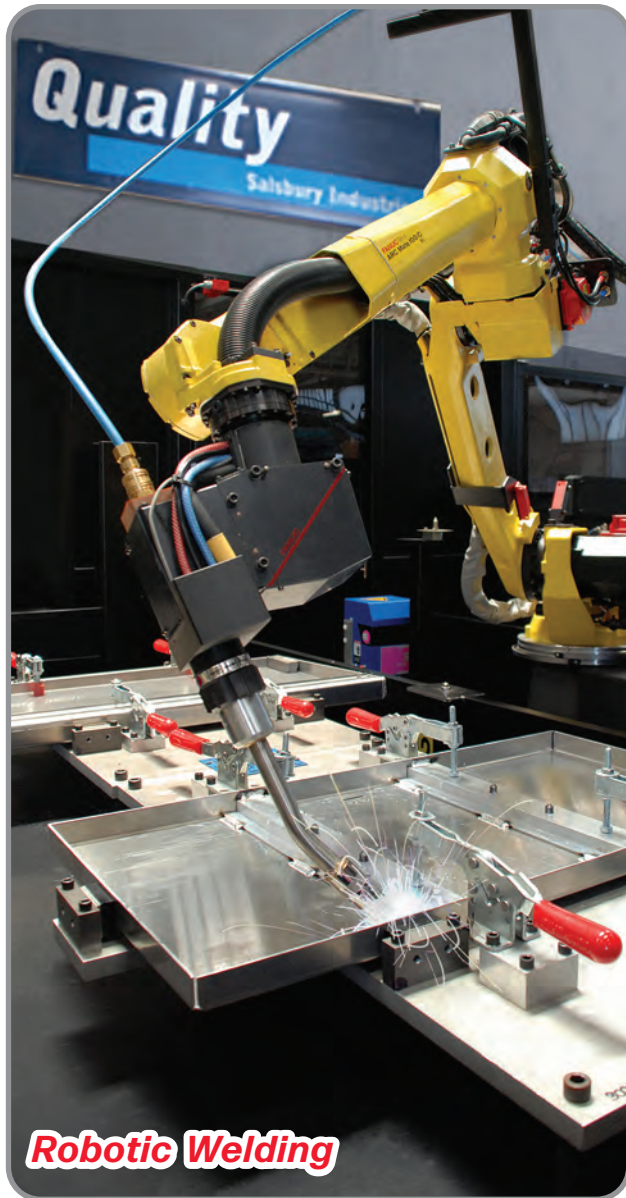

Robotic Welding



Mailbox Showroom

Centralized Mail Delivery

Centralized mail delivery is when the United States Postal Service (U.S.P.S.) delivers mail and parcels to a centralized mail location. Centralized mail delivery is typically required by the U.S.P.S. in new construction and major renovations as it is an efficient method of mail service. Highly visible centralized mail locations are safer than isolated delivery locations and provide protection against mail and parcel theft and vandalism.

Salsbury Industries Cluster Box Units (CBU's - see pages 8-15) and 4C Horizontal Mailboxes (see pages 16-31) are approved by the U.S.P.S. for centralized mail delivery. Salsbury Industries is officially licensed by the U.S.P.S. (U.S.P.S. License # 1CDSEQ-08-B-0026) to manufacture CBU's and is a U.S.P.S. approved manufacturer of 4C Horizontal Mailboxes.



Design Assistance



Architectural Resources

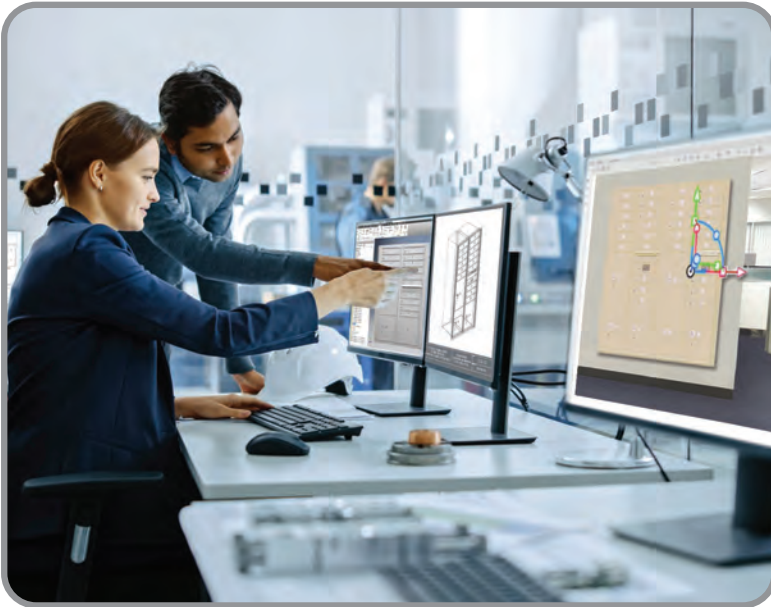

Salsbury Industries design engineers are available to architects, specification writers and individuals involved in the design of mail distribution facilities. Salsbury Industries website features an Architectural Resources section that provides product information, technical drawings, installation instructions, detailed specifications, AutoCAD Drawings, 3D Revit/BIM models and Augmented Reality (AR) models for download. For more information visit: www.mailboxes.com/Architectural-Resources

Online Resources

- Product Information
- 3D Revit / BIM Models
- Detailed Specifications
- Technical Drawings
- Augmented Reality (AR) Models
- Installation Instructions
- AutoCAD Drawings

CBU and 4C Mailbox Configurators



Salsbury Industries CBU and 4C horizontal mailbox configurators are available online and will assist in determining the ideal combination of mailboxes and parcel lockers based on your specific requirements. This robust tool also allows you to customize 4C mailbox units and add numbering sequences to drawings. In addition to clear and easy to read elevation line drawings with dimensions, our online mailbox configurators will also provide you with PDF, Word, Excel and AutoCAD drawing files for your project. Access our configurators at:

www.mailboxes.com/Mailbox-Configurator

Cluster Box Units & Outdoor Parcel Lockers

continued on pages 10 - 15



ALL ALUMINUM CONSTRUCTION

#3316 in sandstone finish displayed

Salsbury Industries is Officially Licensed by the U.S.P.S. to Manufacture Cluster Box Units (CBU's)



Salsbury 3300 series Cluster Box Units (CBU's) are manufactured to U.S.P.S. "F" specifications and are an officially licensed product of the U.S. Postal Service for centralized mail delivery.

U.S.P.S. License #: 1CDSEQ-08-B-0026

CLUSTER BOX UNITS & OUTDOOR PARCEL LOCKERS

FRONT LOADING



Made of heavy duty aluminum and stainless steel hardware, Salsbury 3300 series U.S.P.S. approved Cluster Box Units (CBU's) are accessed from the front through two (2) easy opening master door panels. The Outdoor Parcel Lockers (OPL's) are accessed from the front through one or two (2) easy opening master doors. The durable and corrosion resistant units feature a powder coated finish available in six (6) contemporary colors. Each CBU and OPL includes one or more fully integrated parcel lockers and a matching pedestal. Each pre-numbered aluminum door includes a heavy duty five (5) pin cylinder cam lock with a dust/rain shield and three (3) keys. One additional compartment in each CBU is labeled "Outgoing Mail" and includes a weather protection flap and an 11-3/4" W x 3/4" H mail slot. An attractive option for new and existing CBU and OPL installations are Salsbury 3300R series U.S.P.S. approved Regency® Decorative CBU's and OPL's - see pages 12-13.

Current Pricing and Volume Discounts Available at Mailboxes.com!

CBU MAILBOX CONFIGURATOR



Access our CBU Configurator at: www.mailboxes.com/Mailbox-Configurator

Our CBU mailbox configurator will assist in determining the ideal combination of mailboxes and parcel lockers based on your specific requirements. This robust tool also allows you to add numbering sequences to drawings. In addition to clear and easy to read elevation line drawings with dimensions, our online mailbox configurator will also provide you with PDF, Word, Excel and AutoCAD drawing files to download for your project. Purchasing products and requesting a quote online is simple and convenient.

STANDARD FEATURES FOR CBU'S

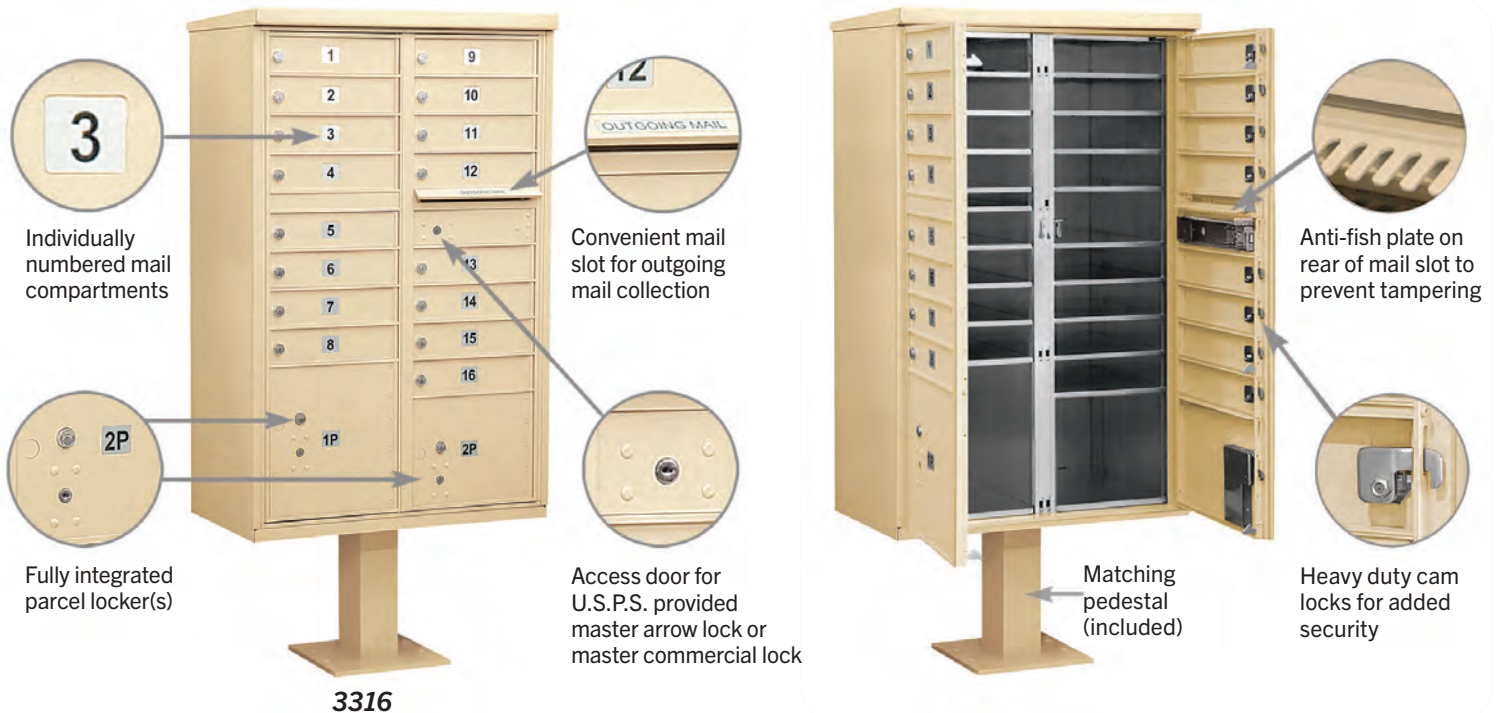

Front views of #3316 in sandstone finish displayed

STANDARD FEATURES FOR OPL'S

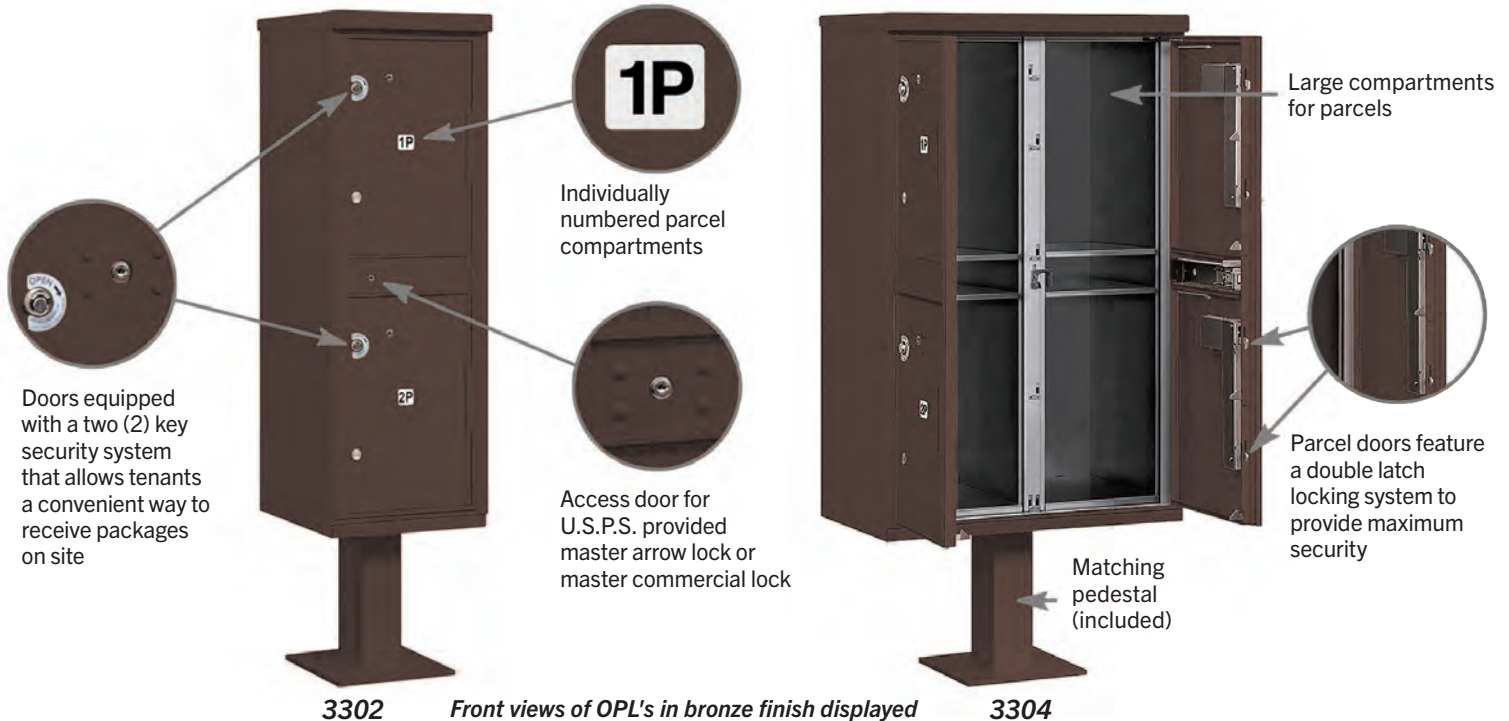

Front views of OPL's in bronze finish displayed

AVAILABLE COLORS

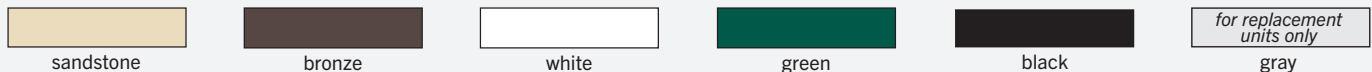

See specifications & options on page 15

Cluster Box Units & Outdoor Parcel Lockers

continued on pages 12 - 15



#3313 in bronze finish displayed

OUTDOOR PARCEL LOCKERS



includes pedestal

3302

DESCRIPTION

3302¹
Outdoor Parcel Locker
2 Compartments - Type I
(2) parcel lockers
(1) pedestal

UNIT SIZE

16" W x 62" H x 18" D
Parcel locker compartment sizes:
12" W x 19-3/4" H x 15" D

WEIGHT

100 lbs.



includes pedestal

3304

DESCRIPTION

3304¹
Outdoor Parcel Locker
4 Compartments - Type II
(4) parcel lockers
(1) pedestal

UNIT SIZE

30-1/2" W x 62" H x 18" D
Parcel locker compartment sizes:
12" W x 19-3/4" H x 15" D

WEIGHT

165 lbs.

Current Pricing and Volume Discounts Available at Mailboxes.com!

CLUSTER BOX UNITS



DESCRIPTION

3308¹
Cluster Box Unit (CBU)
8 "A" Size Doors - Type I

(8) "A" mail compartments
(2) parcel lockers
(1) pedestal

UNIT SIZE

30-1/2" W x 62" H x 18" D

Mail compartment size:
12" W x 3" H x 15" D

Parcel locker compartment sizes:
(1) 12" W x 13-1/2" H x 15" D
(1) 12" W x 10" H x 15" D

WEIGHT

155 lbs.

includes pedestal

3308

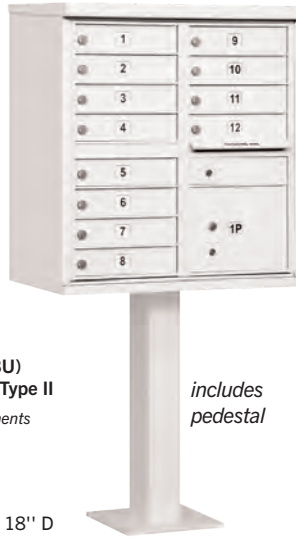

DESCRIPTION

3312¹
Cluster Box Unit (CBU)
12 "A" Size Doors - Type II

(12) "A" mail compartments
(1) parcel locker
(1) pedestal

UNIT SIZE

30-1/2" W x 62" H x 18" D

Mail compartment size:
12" W x 3" H x 15" D

Parcel locker compartment size:
12" W x 10" H x 15" D

WEIGHT

155 lbs.

includes pedestal

3312

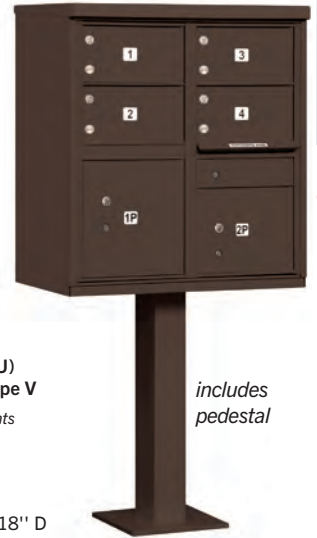

DESCRIPTION

3305¹
Cluster Box Unit (CBU)
4 "C" Size Doors - Type V

(4) "C" mail compartments
(2) parcel lockers
(1) pedestal

UNIT SIZE

30-1/2" W x 62" H x 18" D

Mail compartment size:
12" W x 6-1/2" H x 15" D

Parcel locker compartment sizes:
(1) 12" W x 13-1/2" H x 15" D
(1) 12" W x 10" H x 15" D

WEIGHT

145 lbs.

includes pedestal

3305



DESCRIPTION

3316¹
Cluster Box Unit (CBU)
16 "A" Size Doors - Type III

(16) "A" mail compartments
(2) parcel lockers
(1) pedestal

UNIT SIZE

30-1/2" W x 62" H x 18" D

Mail compartment size:
12" W x 3" H x 15" D

Parcel locker compartment sizes:
(1) 12" W x 13-1/2" H x 15" D
(1) 12" W x 10" H x 15" D

WEIGHT

175 lbs.

includes pedestal

3316



DESCRIPTION

3313¹
Cluster Box Unit (CBU)
13 "B" Size Doors - Type IV

(13) "B" mail compartments
(1) parcel locker
(1) pedestal

UNIT SIZE

30-1/2" W x 62" H x 18" D

Mail compartment size:
12" W x 4-3/4" H x 15" D

Parcel locker compartment size:
12" W x 10" H x 15" D

WEIGHT

165 lbs.

includes pedestal

3313



DESCRIPTION

3306¹
Cluster Box Unit (CBU)
8 "A" Size Doors - Type VI

(8) "A" mail compartments
(4) parcel lockers
(1) pedestal

UNIT SIZE

30-1/2" W x 62" H x 18" D

Mail compartment size:
12" W x 3" H x 15" D

Parcel locker compartment sizes:
(3) 12" W x 13-1/2" H x 15" D
(1) 12" W x 10" H x 15" D

WEIGHT

165 lbs.

includes pedestal

3306

¹ Specify

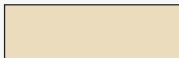

sandstone



bronze



white



green



black

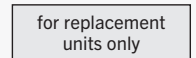

for replacement units only

gray

See specifications & options on page 15

Regency® Decorative CBU's & OPL's

continued on pages 14 - 15

Includes:

- CBU or OPL and Matching Pedestal
- Regency® Decorative Top
- Regency® Pedestal Cover



#3312R in black finish displayed

Salsbury Industries is Officially Licensed by the U.S.P.S. to Manufacture Cluster Box Units (CBU's)



Salsbury 3300 series Cluster Box Units (CBU's) are manufactured to U.S.P.S. "F" specifications and are an officially licensed product of the U.S. Postal Service for centralized mail delivery.

U.S.P.S. License #: 1CDSEQ-08-B-0026

REGENCY® DECORATIVE CBU's & OPL's FRONT LOADING

Made of heavy duty aluminum and stainless steel hardware, Salsbury 3300R series U.S.P.S. approved Regency® Decorative Cluster Box Units (CBU's) and Regency® Decorative Outdoor Parcel Lockers (OPL's) are available in an easy to order complete package that includes a Salsbury 3300 series CBU or OPL and matching pedestal, an attractive decorative top and an elegant decorative pedestal cover. USPS approved decorative tops and pedestal covers are made of die-cast aluminum and can be ordered separately - see page 14.

Current Pricing and Volume Discounts Available at Mailboxes.com!

REGENCY® OUTDOOR PARCEL LOCKER (4 DOOR UNIT ONLY)



DESCRIPTION

3304R¹
Regency® Decorative OPL
4 Compartments - Type II
(4) parcel lockers

UNIT SIZE

31" W x 71-3/4" H x 18-1/2" D

Parcel locker compartment size:
12" W x 19-3/4" H x 15" D

WEIGHT

205 lbs.

3304R



CBU CONFIGURATOR

Our CBU configurator will assist in determining the ideal combination of mailboxes and parcel lockers for your project. In addition to drawings with dimensions, our online mailbox configurator will also provide you with downloadable PDF, Word, Excel and AutoCAD drawing files.

**REGENCY®
CLUSTER BOX
UNITS**



3308R

DESCRIPTION

3308R¹
Regency® Decorative CBU
8 "A" Size Doors - Type I

(8) "A" mail compartments
(2) parcel lockers

UNIT SIZE

31" W x 71-3/4" H x 18-1/2" D

Mail compartment size:
12" W x 3" H x 15" D

Parcel locker compartment sizes:
(1) 12" W x 13-1/2" H x 15" D
(1) 12" W x 10" H x 15" D

WEIGHT

200 lbs.



3312R

DESCRIPTION

3312R¹
Regency® Decorative CBU
12 "A" Size Doors - Type II

(12) "A" mail compartments
(1) parcel locker

UNIT SIZE

31" W x 71-3/4" H x 18-1/2" D

Mail compartment size:
12" W x 3" H x 15" D

Parcel locker compartment size:
12" W x 10" H x 15" D

WEIGHT

200 lbs.



3305R

DESCRIPTION

3305R¹
Regency® Decorative CBU
4 "C" Size Doors - Type V

(4) "C" mail compartments
(2) parcel lockers

UNIT SIZE

31" W x 71-3/4" H x 18-1/2" D

Mail compartment size:
12" W x 6-1/2" H x 15" D

Parcel locker compartment sizes:
(1) 12" W x 13-1/2" H x 15" D
(1) 12" W x 10" H x 15" D

WEIGHT

190 lbs.



3316R

DESCRIPTION

3316R¹
Regency® Decorative CBU
16 "A" Size Doors - Type III

(16) "A" mail compartments
(2) parcel lockers

UNIT SIZE

31" W x 71-3/4" H x 18-1/2" D

Mail compartment size:
12" W x 3" H x 15" D

Parcel locker compartment sizes:
(1) 12" W x 13-1/2" H x 15" D
(1) 12" W x 10" H x 15" D

WEIGHT

215 lbs.



3313R

DESCRIPTION

3313R¹
Regency® Decorative CBU
13 "B" Size Doors - Type IV

(13) "B" mail compartments
(1) parcel locker

UNIT SIZE

31" W x 71-3/4" H x 18-1/2" D

Mail compartment size:
12" W x 4-3/4" H x 15" D

Parcel locker compartment size:
12" W x 10" H x 15" D

WEIGHT

205 lbs.



3306R

DESCRIPTION

3306R¹
Regency® Decorative CBU
8 "A" Size Doors - Type VI

(8) "A" mail compartments
(4) parcel lockers

UNIT SIZE

31" W x 71-3/4" H x 18-1/2" D

Mail compartment size:
12" W x 3" H x 15" D

Parcel locker compartment sizes:
(3) 12" W x 13-1/2" H x 15" D
(1) 12" W x 10" H x 15" D

WEIGHT

205 lbs.

¹ Specify

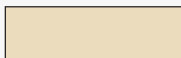

sandstone



bronze



white



green



black

See specifications & options on page 15

CBU & OPL Specifications & Options

for CBU's, OPL's and Regency® CBU's/OPL's on pages 8 - 13

REGENCY® DECORATIVE CBU & OPL ACCESSORIES - U.S.P.S. APPROVED

Made of die cast aluminum, Salsbury U.S.P.S. approved Regency® Decorative CBU and OPL accessories can be ordered separately from Salsbury 3300 series CBU's and OPL's. Decorative accessories feature a durable powder coated finish available in five (5) contemporary colors and provide an elegant finished look to CBU and OPL installations. Decorative tops (#3350) include a 3" diameter ball finial and an attractive sloping design and easily mount to the top of CBU's and OPL's with four (4) set screws (provided). Decorative pedestal covers (short - #3386 and tall - #3396) easily attach over CBU and OPL pedestals and include a plastic insect guard and installation hardware.

SAMPLE INSTALLATION OF REGENCY® DECORATIVE CBU/OPL ACCESSORIES

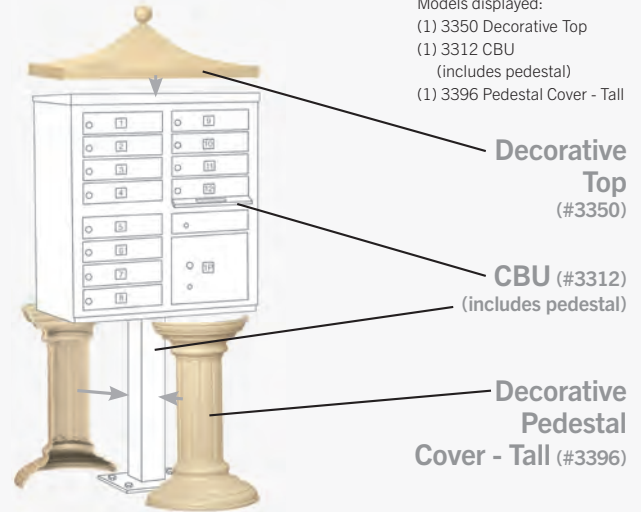

Models displayed:
(1) 3350 Decorative Top
(1) 3312 CBU
(includes pedestal)
(1) 3396 Pedestal Cover - Tall

Note: Regency® decorative tops and pedestal covers are available in a complete package that includes the CBU/OPL and pedestal (see pages 12-13).

DESCRIPTION

3350¹ - Regency® Decorative Top

- Option for #3308, #3312, #3316, #3313, #3305, #3306 and #3304
- 31" W x 11-1/2" H x 18-1/2" D

WEIGHT
20 lbs.



3350

DESCRIPTION

3386¹ - Regency® Pedestal Cover - Short

- Option for pedestal for #3316, #3313, #3306 and #3304
- 13-3/4" H x 17-3/4" diameter

WEIGHT
20 lbs.



3386

DESCRIPTION

3396¹ - Regency® Pedestal Cover - Tall

- Option for pedestal for #3308, #3312 and #3305
- 27-3/4" H x 17-3/4" diameter

WEIGHT
25 lbs.



3396

¹ Specify



sandstone bronze white green black

DESIGN ASSISTANCE

Our design engineers are available to architects, specification writers and individuals involved in the design of mail distribution facilities, apartment complexes and commercial buildings. Visit the informative Architect Resources section of our website at: www.mailboxes.com/Architectural-Resources to download specifications, technical drawings, AutoCAD, BIM/Revit models and Augmented Reality (AR) models. You can also submit required layout and options for a price quotation.



#3316R and #3306R in sandstone finish with optional custom engraved doors - black filled (#3374) displayed



#3316's and #3304 in bronze finish with optional custom engraved placards (#3367) displayed

CBU MAILBOX CONFIGURATOR

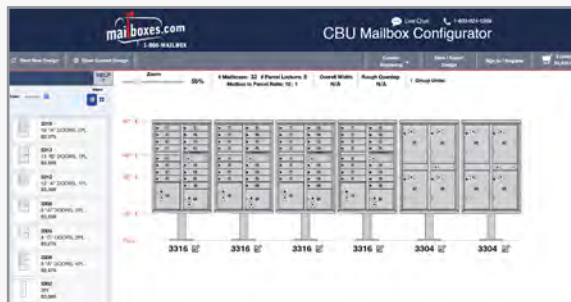

Access our CBU Configurator at:
www.mailboxes.com/Mailbox-Configurator

Our CBU mailbox configurator will assist in determining the ideal combination of mailboxes and parcel lockers based on your specific requirements. This robust tool also allows you to add numbering sequences to drawings. In addition to clear and easy to read elevation line drawings with dimensions, our online mailbox configurator will also provide you with PDF, Word, Excel and AutoCAD drawing files to download for your project. Purchasing products and requesting a quote online is simple and convenient.

CLUSTER BOX UNITS & OUTDOOR PARCEL LOCKERS SPECIFICATIONS & OPTIONS

MAILBOX DOOR SIZES

Each aluminum mailbox door includes a heavy duty five (5) pin cylinder cam lock with a dust/rain shield and three (3) keys.

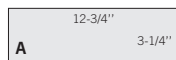

#3351¹ Replacement "A" door and lock

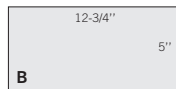

#3352¹ Replacement "B" door and lock

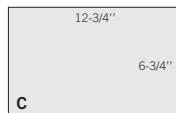

#3356¹ Replacement "C" door and lock

OUTGOING MAIL SLOT PLUG KIT

An outgoing mail slot plug kit is available for installations not serviced by the U.S.P.S. (#3370)



#3370

PARCEL LOCKER DOOR SIZES

Each CBU/OPL includes one or more fully integrated parcel lockers. Parcel lockers offer tenants a convenient way to receive packages on site and are equipped with a two (2) key security system.

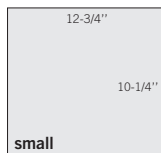

small

#3353¹ Replacement parcel locker door and tenant lock - small

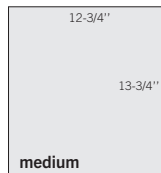

medium

#3354¹ Replacement parcel locker door and tenant lock - medium

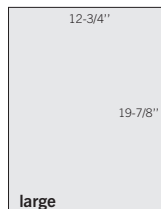

large

#3355¹ Replacement parcel locker door and tenant lock - large

FINISHES

Durable and corrosion resistant CBU's/OPL's feature a powder coated finish available in sandstone, bronze, white, green or black. Note - gray is available for replacement units only and is not available on Regency Decorative CBU's/OPL's and accessories.

1 Specify

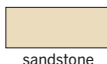

sandstone



bronze

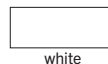

white



green



black

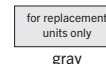

gray

IDENTIFICATION SYSTEMS

Each CBU/OPL door has a 1" high self adhesive number. The outgoing mail compartment is labeled "Outgoing Mail" and the parcel locker(s) are labeled with a "1P", "2P", etc. Custom identification systems are available as an option upon request.

CUSTOM ENGRAVED DOOR PLACARDS

1-3/4" W x 1-1/2" H custom engraved self-adhesive door placards are available as an option upon request. (#3367)



#3367

CUSTOM ENGRAVED UNIT PLACARDS

8" W x 1" H custom engraved self-adhesive unit placards are available as an option upon request. (#3363)



#3363

CUSTOM ENGRAVED DOORS

- Custom engraved door – regular (#3368)
- Custom engraved door – black filled (#3374)

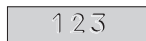

#3368

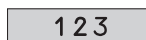

#3374

LOCKS

Each CBU/OPL door includes a heavy duty five (5) pin cylinder cam lock with a dust/rain shield and three (3) keys (2,000 different key changes). (#3390-5 - set of (5) #3390 locks)

- Additional keys per lock when ordering (#3398)
- Key blanks - box of (50) (#3399)

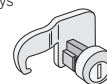

#3390

MASTER COMMERCIAL LOCK

Factory installed if for private access - for access door and parcel locker(s) - with (2) keys (#3375)

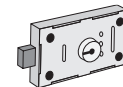

#3375

TENANT PARCEL LOCKER LOCK

For parcel locker door - with (3) keys (#3376)

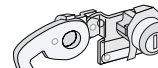

#3376

OUTDOOR PARCEL LOCK CYLINDER

For outdoor parcel locker door - with (3) keys (#3377)



#3377

Note: For E series replacement CBU locks, see 3390E on page 50.

PEDESTALS

- #3385¹ Replacement pedestal for #3316, #3313, #3306, #3302 and #3304 (14-1/2" H)
- #3395¹ Replacement pedestal for #3308, #3312 and #3305 (28-1/2" H)
- #3285 Replacement pedestal for the Neighborhood Delivery and Collection Box Unit (NDCBU)
- #3393 Pedestal mounting kit - (4) 5-1/2" H expansion wedge anchor bolts - for existing concrete
- #3394 Pedestal mounting kit - (4) 1/2" W x 8" H anchor (J) bolts - for new concrete

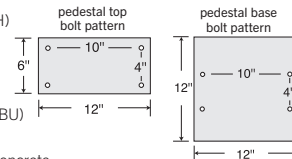

OUTGOING MAIL COMPARTMENT
 Cluster Box Units (CBU's) include a compartment for outgoing mail collection that is labeled "Outgoing Mail".

Recessed Mounted 4C Horizontal Mailboxes

continued on pages 18 - 19

RECESSED MOUNTED 4C HORIZONTAL MAILBOXES

FRONT LOADING 

Made of heavy duty aluminum and stainless steel hardware, Salsbury 3700 series recessed mounted 4C horizontal mailboxes and parcel lockers are U.S.P.S. approved and are available with standard MB1 mailbox doors (12-3/4" W x 3-1/4" H). Larger MB2, MB3 and MB4 mailbox doors are available for custom units – see door sizes on page 31. All pre-numbered mailbox doors include a heavy duty cam lock with a dust/rain shield and three (3) keys. Recessed mounted 4C horizontal mailbox units include factory installed 1" W x 1/4" D trim and are available in configurations that are one door wide (single column) and two (2) doors wide (double column). The Salsbury maximum height units (3716D-15) have three (3) fully integrated parcel lockers (2 PL4.5 and 1PL5) and fifteen (15) standard MB1 mailbox doors and meet the U.S.P.S. 4C requirement of one parcel locker for every five (5) tenant compartments. Fully integrated and stand-alone parcel lockers are available in heights ranging from the equivalent of three (3) standard MB1 mailbox doors (PL3 - 10-1/4" high) to six (6) standard MB1 mailbox doors (PL6 - 20-3/4" high). Each unit includes a compartment for outgoing mail collection and is labeled "Outgoing Mail". The outgoing mail compartment includes a weather protection flap and a 11-3/4" W x 3/4" H mail slot. Designed for indoor or outdoor use, recessed mounted 4C horizontal mailboxes feature a durable powder coated finish available in four (4) contemporary colors.

4C

Note: Salsbury 3700 series recessed mounted 4C horizontal mailboxes and parcel lockers are U.S.P.S. approved and meet the specifications of USPS-STD-4C. These units are required for new construction and major renovations.

STANDARD FEATURES

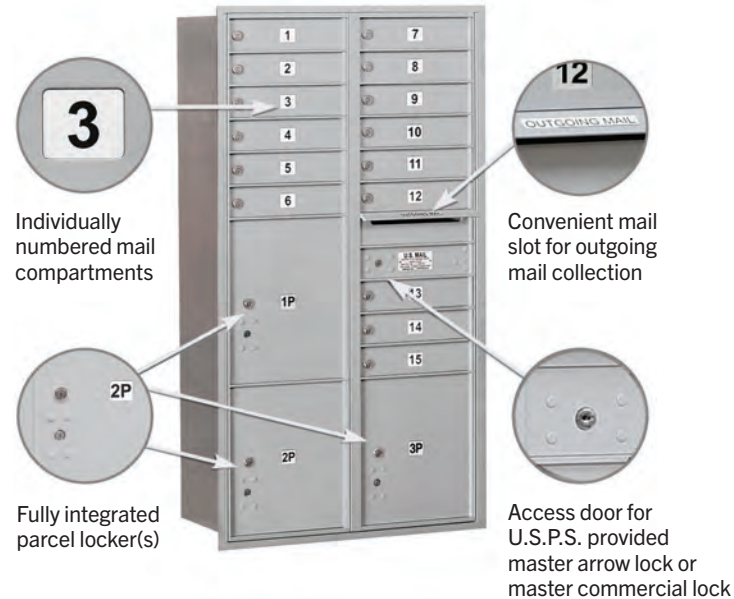

Front view of 3716D-15 Front Loading Recessed Mounted Double Column Unit displayed



**ALL ALUMINUM
CONSTRUCTION**

#3716D-15 maximum height recessed mounted 4C horizontal mailboxes in aluminum finish with optional custom engraved placards (#3767) displayed

MAXIMUM HEIGHT UNITS - 57-1/8" H

11 DOOR HIGH UNITS - 41-3/8" H



3716D-20
Double Column - Front Loading



3716D-15
Double Column - Front Loading



3711D-20
Double Column - Front Loading



3711D-10
Double Column - Front Loading

RECESSED MOUNTED 4C HORIZONTAL MAILBOXES - FRONT LOADING - U.S.P.S. APPROVED

MODEL	DESCRIPTION	UNIT SIZE (includes trim)	WEIGHT
MAXIMUM HEIGHT UNITS - 57-1/8" H (maximum allowable height)			
3716D-20 ^{1,2}	20 MB1 Doors and 2 Parcel Lockers (PL4.5's)	31-1/8" W x 57-1/8" H x 16-1/2" D	170 lbs.
3716D-15 ^{1,2}	15 MB1 Doors and 3 Parcel Lockers (PL4.5's, PL5)	31-1/8" W x 57-1/8" H x 16-1/2" D	160 lbs.
3716D-10 ^{1,2}	10 MB1 Doors and 4 Parcel Lockers (PL4.5's, PL5's)	31-1/8" W x 57-1/8" H x 16-1/2" D	150 lbs.
3716D-6P ^{1,2}	6 Parcel Lockers (PL4.5's, PL5's, PL6's)	31-1/8" W x 57-1/8" H x 16-1/2" D	145 lbs.
3716S-09 ^{1,2}	9 MB1 Doors and 1 Parcel Locker (PL4.5)	17" W x 57-1/8" H x 16-1/2" D	85 lbs.
3716S-06 ^{1,2}	6 MB1 Doors and 2 Parcel Lockers (PL3, PL4.5)	17" W x 57-1/8" H x 16-1/2" D	85 lbs.
3716S-3P ^{1,2}	3 Parcel Lockers (PL4.5, PL5, PL6)	17" W x 57-1/8" H x 16-1/2" D	80 lbs.

MAXIMUM HEIGHT UNITS - 57-1/8" H

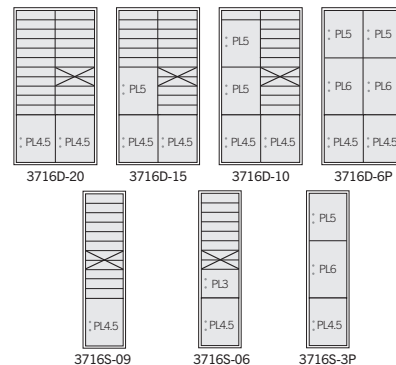

MODEL	DESCRIPTION	UNIT SIZE (includes trim)	WEIGHT
11 DOOR HIGH UNITS - 41-3/8" H (equivalent to 11 standard mailbox doors (MB1) high)			
3711D-20 ^{1,2}	20 MB1 Doors - no Parcel Lockers	31-1/8" W x 41-3/8" H x 16-1/2" D	145 lbs.
3711D-15 ^{1,2}	15 MB1 Doors and 1 Parcel Locker (PL5)	31-1/8" W x 41-3/8" H x 16-1/2" D	135 lbs.
3711D-10 ^{1,2}	10 MB1 Doors and 2 Parcel Lockers (PL5's)	31-1/8" W x 41-3/8" H x 16-1/2" D	135 lbs.
3711D-4P ^{1,2}	4 Parcel Lockers (PL5's, PL6's)	31-1/8" W x 41-3/8" H x 16-1/2" D	130 lbs.
3711S-09 ^{1,2}	9 MB1 Doors - no Parcel Lockers	17" W x 41-3/8" H x 16-1/2" D	75 lbs.
3711S-04 ^{1,2}	4 MB1 Doors and 1 Parcel Locker (PL5)	17" W x 41-3/8" H x 16-1/2" D	75 lbs.
3711S-2P ^{1,2}	2 Parcel Lockers (PL5, PL6)	17" W x 41-3/8" H x 16-1/2" D	65 lbs.

11 DOOR HIGH UNITS - 41-3/8" H

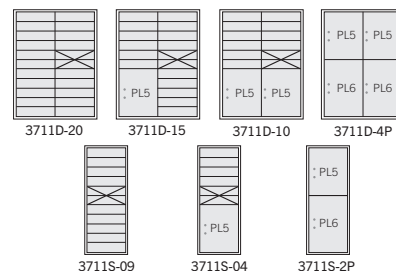

Current Pricing and Volume Discounts Available at Mailboxes.com!

¹ Specify

aluminum

bronze

sandstone

black

² Specify - U.S.P.S. access or private access (order #3775 master commercial lock for private access on FL units and PL's)

more
recessed mounted
4C horizontal mailboxes
available on pages 18-19 and online

Recessed Mounted 4C Horizontal Mailboxes

for custom 4C mailbox units and options — see pages 28-31

ARCHITECTURAL RESOURCES ONLINE

visit: www.mailboxes.com/Architectural-Resources

- Product Information
- 3D Revit / BIM Models
- Augmented Reality (AR) Models
- Detailed Specifications
- Technical Drawings
- Installation Instructions
- AutoCAD Drawings
- Color Chart
- ADA Compliant Units Available 

- see page 19 or visit: www.mailboxes.com/ADA-4C-Mailboxes



4C

Note: Salisbury 3700 series recessed mounted 4C horizontal mailboxes and parcel lockers are U.S.P.S. approved and meet the specifications of USPS-STD-4C. These units are required for new construction and major renovations.

4C MAILBOX CONFIGURATOR

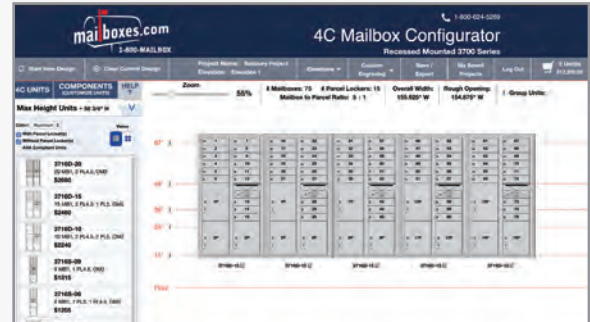

Access our 4C Configurator at:
www.mailboxes.com/Mailbox-Configurator

Our 4C mailbox configurator will assist in determining the ideal combination of mailboxes and parcel lockers based on your specific requirements. This robust tool also allows you to customize 4C mailbox units and add numbering sequences to drawings. In addition to clear and easy to read elevation line drawings with dimensions, our online mailbox configurator will also provide you with PDF, Word, Excel and AutoCAD drawing files to download for your project. Purchasing products and requesting a quote online is simple and convenient.

4C CONNECTOR KIT

Made of heavy duty aluminum, 4C horizontal mailbox connector kits easily connect multiple recessed mounted mailbox units providing easy installation. Each standard and custom recessed mounted 4C horizontal mailbox unit includes one mailbox connector kit (hardware included).

- Models displayed:
(2) 3716D-15 Front Loading Units
(1) 3716CK Connector Kit

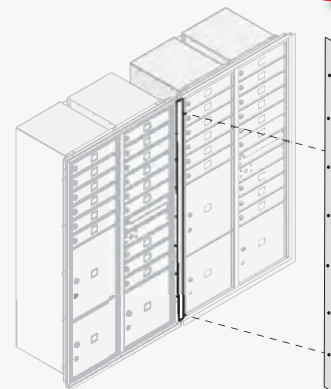

4C horizontal mailbox connector kits connect recessed mounted units side by side and eliminate the need for wood studs between the units.

Note: For installations accessed by the U.S. Postal Service, the tenant locks in the top row of mailboxes must be no more than 67" above the finished floor and the bottom shelf of the lowest row of mailboxes must be no less than 28" above the finished floor. The U.S.P.S. master arrow lock must be a minimum of 36" and a maximum of 48" above the finished floor. The bottom shelf of parcel lockers must be at least 15" above the finished floor.



#3710D-10 recessed mounted 4C horizontal mailboxes in bronze finish with optional custom engraved placards (#3767) displayed

10 DOOR HIGH UNITS* - 37-7/8" H

6 DOOR HIGH UNITS* - 23-7/8" H



3710D-10

Double Column - Front Loading



3710S-04

Single Column - Front Loading



3706D-10

Double Column - Front Loading



3706S-04

Single Column - Front Loading



* All units meet ADA reach requirements when installed with the tenant locks in the top row of mailboxes no more than 48" above the finished floor and the bottom shelf of the lowest row of mailboxes no less than 28" above the finished floor.

RECESSED MOUNTED 4C HORIZONTAL MAILBOXES - FRONT LOADING - U.S.P.S. APPROVED

MODEL	DESCRIPTION	UNIT SIZE (includes trim)	WEIGHT
10 DOOR HIGH UNITS - 37-7/8" H (equivalent to 10 standard mailbox doors (MB1) high)			
3710D-10 ^{1,2}	10 MB1 Doors and 2 Parcel Lockers (PL4, PL4.5)	31-1/8" W x 37-7/8" H x 16-1/2" D	130 lbs.
3710D-09 ^{1,2}	9 MB1 Doors and 2 Parcel Lockers (PL4.5, PL5)	31-1/8" W x 37-7/8" H x 16-1/2" D	130 lbs.
3710D-06 ^{1,2}	6 MB1 Doors and 2 Parcel Lockers (PL6's)	31-1/8" W x 37-7/8" H x 16-1/2" D	125 lbs.
3710D-4P ^{1,2}	4 Parcel Lockers (PL5's)	31-1/8" W x 37-7/8" H x 16-1/2" D	120 lbs.
3710S-04 ^{1,2}	4 MB1 Doors and 1 Parcel Locker (PL4.5)	17" W x 37-7/8" H x 16-1/2" D	75 lbs.
3710S-03 ^{1,2}	3 MB1 Doors and 1 Parcel Locker (PL5)	17" W x 37-7/8" H x 16-1/2" D	70 lbs.
3710S-2P ^{1,2}	2 Parcel Lockers (PL5's)	17" W x 37-7/8" H x 16-1/2" D	65 lbs.

10 DOOR HIGH UNITS - 37-7/8" H

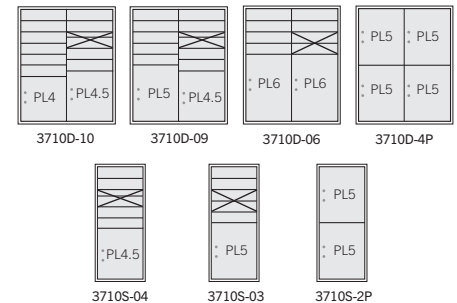

MODEL	DESCRIPTION	UNIT SIZE (includes trim)	WEIGHT
6 DOOR HIGH UNITS - 23-7/8" H (equivalent to 6 standard mailbox doors (MB1) high)			
3706D-10 ^{1,2}	10 MB1 Doors - no Parcel Lockers	31-1/8" W x 23-7/8" H x 16-1/2" D	90 lbs.
3706D-09 ^{1,2}	9 MB1 Doors - no Parcel Lockers	31-1/8" W x 23-7/8" H x 16-1/2" D	90 lbs.
3706D-05 ^{1,2}	5 MB1 Doors and 1 Parcel Locker (PL5)	31-1/8" W x 23-7/8" H x 16-1/2" D	85 lbs.
3706D-2P ^{1,2}	2 Parcel Lockers (PL6's)	31-1/8" W x 23-7/8" H x 16-1/2" D	80 lbs.
3706S-04 ^{1,2}	4 MB1 Doors - no Parcel Lockers	17" W x 23-7/8" H x 16-1/2" D	50 lbs.
3706S-03 ^{1,2}	3 MB1 Doors - no Parcel Lockers	17" W x 23-7/8" H x 16-1/2" D	50 lbs.
3706S-1P ^{1,2}	1 Parcel Locker (PL6)	17" W x 23-7/8" H x 16-1/2" D	45 lbs.

6 DOOR HIGH UNITS - 23-7/8" H

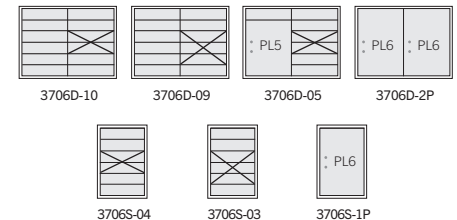

Current Pricing and Volume Discounts Available at Mailboxes.com!

¹ Specify

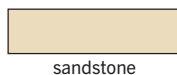

² Specify - U.S.P.S. access or private access (order #3775 master commercial lock for private access on FL units and PL's)

OUTGOING MAIL COMPARTMENT
 Note: Recessed mounted 4C horizontal mailboxes include a compartment for outgoing mail collection that is labeled "Outgoing Mail".

For custom 4C mailbox units, specifications & options - see pages 28-31

Surface Mounted 4C Horizontal Mailboxes

continued on pages 22 - 23

SURFACE MOUNTED 4C HORIZONTAL MAILBOXES FRONT LOADING

Made of heavy duty aluminum and stainless steel hardware, Salsbury 3800 series surface mounted 4C horizontal mailboxes are accessed from the front through one or two (2) easy opening master door panels. Surface mounted 4C horizontal mailboxes include a U.S.P.S. approved 4C horizontal mailbox, master commercial lock(s) and matching surface mounted enclosure and are available in configurations that are one door wide (single column) and two (2) doors wide (double column). The durable and corrosion resistant units feature a powder coated finish available in four (4) contemporary colors and are designed for indoor and outdoor use. Surface mounted 4C horizontal mailboxes are available with standard mailbox doors (MB1) that are 12-3/4" W x 3-1/4" H. Larger MB2, MB3 and MB4 mailbox doors are available for custom units - see door sizes on page 31. All pre-numbered mailbox doors include a heavy duty cam lock with a dust/rain shield and three (3) keys. Each unit includes a compartment for outgoing mail collection and is labeled "Outgoing Mail". The outgoing mail compartment includes a weather protection flap and an 11-3/4" W x 3/4" H mail slot. Fully integrated and stand-alone parcel lockers are available in heights ranging from the equivalent of three (3) standard MB1 mailbox doors (PL3 - 10-1/4" high) to six (6) standard MB1 mailbox doors (PL6 - 20-3/4" high). The Salsbury maximum height units (3816D-15) have three (3) fully integrated parcel lockers (2 PL4.5 and 1PL5) and fifteen (15) standard MB1 mailbox doors providing one parcel locker for every five (5) tenant compartments. Surface mounted 4C horizontal mailboxes provide a convenient means of installing 4C horizontal mailboxes in locations where walls cannot accommodate a recessed mounted installation. For U.S.P.S. approved recessed mounted units, please see our recessed mounted 4C horizontal mailboxes on pages 16-19.



#3816D-15 maximum height surface mounted 4C horizontal mailbox unit in aluminum finish displayed

4C

Note: Salsbury 3800 series surface mounted 4C horizontal mailboxes include a U.S.P.S. approved 4C horizontal mailbox unit, a matching enclosure and master commercial lock(s) for private access. For access by the U.S. Postal Service, contact your local postmaster for approval.

4C MAILBOX CONFIGURATOR



Access our 4C Configurator at:
www.mailboxes.com/Mailbox-Configurator

Our 4C mailbox configurator will assist in determining the ideal combination of mailboxes and parcel lockers based on your specific requirements. This robust tool also allows you to customize 4C mailbox units and add numbering sequences to drawings. In addition to clear and easy to read elevation line drawings with dimensions, our online mailbox configurator will also provide you with PDF, Word, Excel and AutoCAD drawing files to download for your project. Purchasing products and requesting a quote online is simple and convenient.

SAMPLE SURFACE MOUNT INSTALLATION

Model displayed: 3816D-15

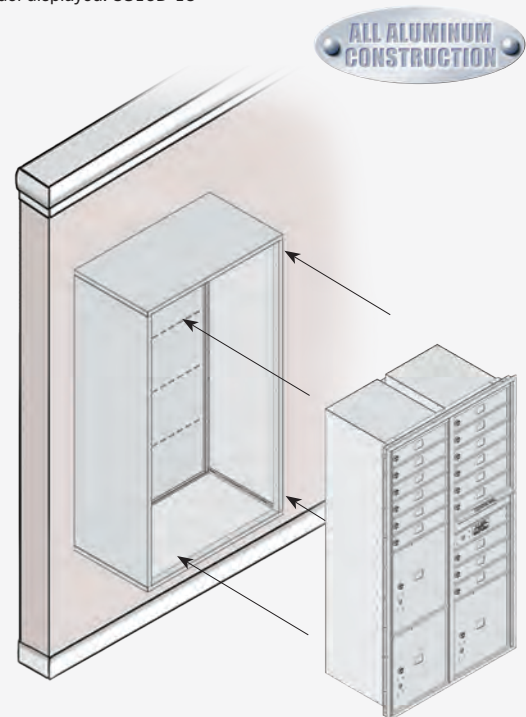

MAXIMUM HEIGHT UNITS - 57-3/4" H

11 DOOR HIGH UNITS - 42" H



3816D-20



3816D-15



3811D-20



3811D-10

SURFACE MOUNTED 4C HORIZONTAL MAILBOXES - INCLUDES 4C MAILBOX AND ENCLOSURE

MODEL	DESCRIPTION	UNIT SIZE (includes enclosure)	WEIGHT
MAXIMUM HEIGHT UNITS - 57-3/4" H (includes enclosure)			
3816D-20 ¹	20 MB1 Doors and 2 Parcel Lockers (PL4.5's)	31-3/4" W x 57-3/4" H x 17" D	225 lbs.
3816D-15 ¹	15 MB1 Doors and 3 Parcel Lockers (PL4.5's, PL5)	31-3/4" W x 57-3/4" H x 17" D	215 lbs.
3816D-10 ¹	10 MB1 Doors and 4 Parcel Lockers (PL4.5's, PL5's)	31-3/4" W x 57-3/4" H x 17" D	205 lbs.
3816D-6P ¹	6 Parcel Lockers (PL4.5's, PL5's, PL6's)	31-3/4" W x 57-3/4" H x 17" D	200 lbs.
3816S-09 ¹	9 MB1 Doors and 1 Parcel Locker (PL4.5)	17-3/4" W x 57-3/4" H x 17" D	130 lbs.
3816S-06 ¹	6 MB1 Doors and 2 Parcel Lockers (PL3, PL4.5)	17-3/4" W x 57-3/4" H x 17" D	130 lbs.
3816S-3P ¹	3 Parcel Lockers (PL4.5, PL5, PL6)	17-3/4" W x 57-3/4" H x 17" D	125 lbs.

MAXIMUM HEIGHT UNITS - 57-3/4" H

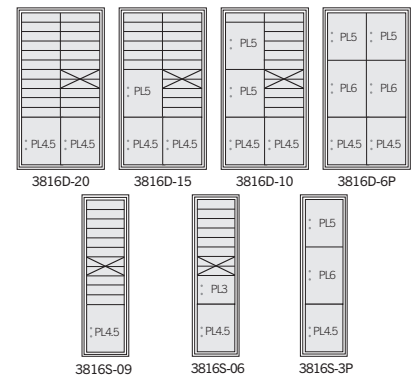

MODEL	DESCRIPTION	UNIT SIZE (includes enclosure)	WEIGHT
11 DOOR HIGH UNITS - 42" H (includes enclosure)			
3811D-20 ¹	20 MB1 Doors - no Parcel Lockers	31-3/4" W x 42" H x 17" D	185 lbs.
3811D-15 ¹	15 MB1 Doors and 1 Parcel Locker (PL5)	31-3/4" W x 42" H x 17" D	175 lbs.
3811D-10 ¹	10 MB1 Doors and 2 Parcel Lockers (PL5's)	31-3/4" W x 42" H x 17" D	175 lbs.
3811D-4P ¹	4 Parcel Lockers (PL5's, PL6's)	31-3/4" W x 42" H x 17" D	170 lbs.
3811S-09 ¹	9 MB1 Doors - no Parcel Lockers	17-3/4" W x 42" H x 17" D	105 lbs.
3811S-04 ¹	4 MB1 Doors and 1 Parcel Locker (PL5)	17-3/4" W x 42" H x 17" D	105 lbs.
3811S-2P ¹	2 Parcel Lockers (PL5, PL6)	17-3/4" W x 42" H x 17" D	95 lbs.

11 DOOR HIGH UNITS - 42" H

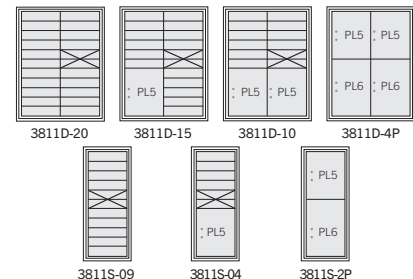

Current Pricing and Volume Discounts Available at Mailboxes.com!

¹ Specify



more
surface mounted
4C horizontal mailboxes
available on pages 22-23 and online

Surface Mounted 4C Horizontal Mailboxes

for custom 4C mailbox units and options — see pages 28 - 31

- Ideal for Private Mail Delivery Applications Including Military Bases and Student Housing
- Designed for Installations with Limited Wall Depth
- Easily Mounted to Any Flat Surface
- Fully Integrated Parcel Locker(s)
- For Indoor or Outdoor Use
- Engraved Doors or Placards Available
- ADA Compliant Units Available  - see page 23 or visit: www.mailboxes.com/ADA-4C-Mailboxes



#3810D-10 surface mounted 4C horizontal mailboxes in sandstone finish with optional custom engraved placards (#3767) displayed

4C

Note: Salsbury 3800 series surface mounted 4C horizontal mailboxes include a U.S.P.S. approved 4C horizontal mailbox unit, a matching enclosure and master commercial lock(s) for private access. For access by the U.S. Postal Service, contact your local postmaster for approval.

STANDARD FEATURES

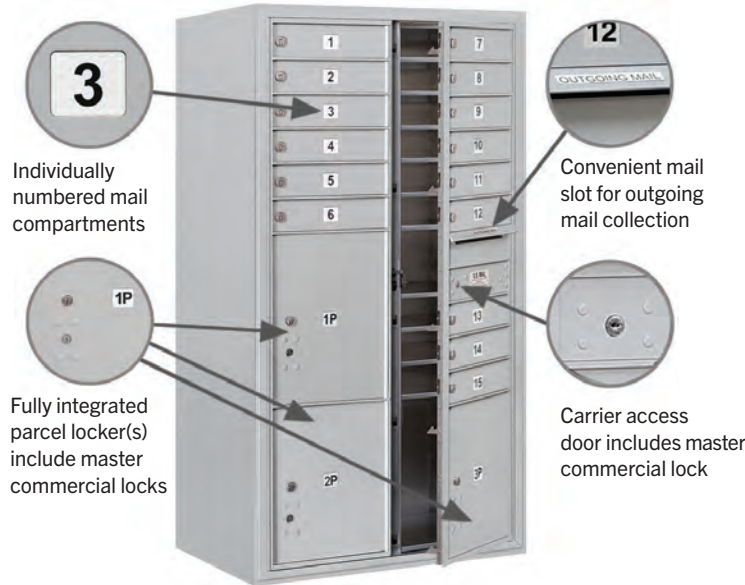

Front views of 3816D-15 in aluminum finish displayed



**ALL ALUMINUM
CONSTRUCTION**

10 DOOR HIGH UNITS* - 38-1/2" H

6 DOOR HIGH UNITS* - 24-1/2" H



3810D-10



3810S-04



3806D-10



3806S-04



* All units meet ADA reach requirements when installed with the tenant locks in the top row of mailboxes no more than 48" above the finished floor and the bottom shelf of the lowest row of mailboxes no less than 28" above the finished floor.

SURFACE MOUNTED 4C HORIZONTAL MAILBOXES - INCLUDES 4C MAILBOX AND ENCLOSURE

MODEL	DESCRIPTION	UNIT SIZE (includes enclosure)	WEIGHT
10 DOOR HIGH UNITS - 38-1/2" H (includes enclosure)			
3810D-10 ¹	10 MB1 Doors and 2 Parcel Lockers (PL4, PL4.5)	31-3/4" W x 38-1/2" H x 17" D	165 lbs.
3810D-09 ¹	9 MB1 Doors and 2 Parcel Lockers (PL4.5, PL5)	31-3/4" W x 38-1/2" H x 17" D	165 lbs.
3810D-06 ¹	6 MB1 Doors and 2 Parcel Lockers (PL6's)	31-3/4" W x 38-1/2" H x 17" D	160 lbs.
3810D-4P ¹	4 Parcel Lockers (PL5's)	31-3/4" W x 38-1/2" H x 17" D	155 lbs.
3810S-04 ¹	4 MB1 Doors and 1 Parcel Locker (PL4.5)	17-3/4" W x 38-1/2" H x 17" D	100 lbs.
3810S-03 ¹	3 MB1 Doors and 1 Parcel Locker (PL5)	17-3/4" W x 38-1/2" H x 17" D	95 lbs.
3810S-2P ¹	2 Parcel Lockers (PL5's)	17-3/4" W x 38-1/2" H x 17" D	90 lbs.

10 DOOR HIGH UNITS - 38-1/2" H

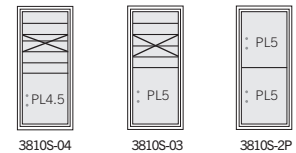
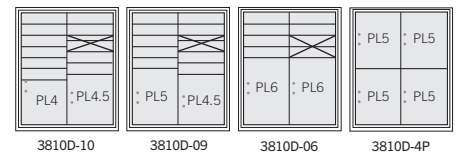

MODEL	DESCRIPTION	UNIT SIZE (includes enclosure)	WEIGHT
6 DOOR HIGH UNITS - 24-1/2" H (includes enclosure)			
3806D-10 ¹	10 MB1 Doors - no Parcel Lockers	31-3/4" W x 24-1/2" H x 17" D	115 lbs.
3806D-09 ¹	9 MB1 Doors - no Parcel Lockers	31-3/4" W x 24-1/2" H x 17" D	115 lbs.
3806D-05 ¹	5 MB1 Doors and 1 Parcel Locker (PL5)	31-3/4" W x 24-1/2" H x 17" D	110 lbs.
3806D-2P ¹	2 Parcel Lockers (PL6's)	31-3/4" W x 24-1/2" H x 17" D	105 lbs.
3806S-04 ¹	4 MB1 Doors - no Parcel Lockers	17-3/4" W x 24-1/2" H x 17" D	65 lbs.
3806S-03 ¹	3 MB1 Doors - no Parcel Lockers	17-3/4" W x 24-1/2" H x 17" D	65 lbs.
3806S-1P ¹	1 Parcel Locker (PL6)	17-3/4" W x 24-1/2" H x 17" D	60 lbs.

6 DOOR HIGH UNITS - 24-1/2" H

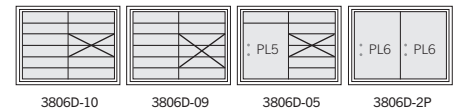

Current Pricing and Volume Discounts Available at Mailboxes.com!

¹ Specify

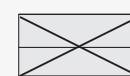

OUTGOING MAIL COMPARTMENT

Note: Surface mounted 4C horizontal mailboxes include a compartment for outgoing mail collection that is labeled "Outgoing Mail".

For custom 4C mailbox units, specifications & options - see pages 28-31

Free-Standing 4C Horizontal Mailboxes

continued on pages 26 - 27

FREE-STANDING 4C HORIZONTAL MAILBOXES FRONT LOADING PRIVATE ACCESS

Made of heavy duty aluminum and stainless steel hardware, Salsbury 3900 series free-standing 4C horizontal mailboxes are accessed from the front through one or two (2) easy opening master door panels. Free-standing 4C horizontal mailboxes include a U.S.P.S. approved 4C horizontal mailbox, master commercial lock(s) and matching free-standing enclosure and are available in configurations that are one door wide (single column) and two (2) doors wide (double column). The durable and corrosion resistant units feature a powder coated finish available in four (4) contemporary colors and are designed for indoor and outdoor use. Free-standing 4C mailboxes are available with standard mailbox doors (MB1) that are 12-3/4" W x 3-1/4" H. Larger MB2, MB3 and MB4 mailbox doors are available for custom units - see door sizes on page 31. All pre-numbered mailbox doors include a heavy duty cam lock with a dust/rain shield and three (3) keys. Each unit includes a compartment for outgoing mail collection and is labeled "Outgoing Mail". The outgoing mail compartment includes a weather protection flap and an 11-3/4" W x 3/4" H mail slot. Fully integrated and stand-alone parcel lockers are available in heights ranging from the equivalent of three (3) standard MB1 mailbox doors (PL3 - 10-1/4" high) to six (6) standard MB1 mailbox doors (PL6 - 20-3/4" high). The Salsbury maximum height units (3916D-15) have three (3) fully integrated parcel lockers (2 PL4.5 and 1PL5) and fifteen (15) standard MB1 mailbox doors providing one parcel locker for every five (5) tenant compartments. Free-standing 4C horizontal mailboxes provide a convenient means of installing 4C horizontal mailboxes in locations where a wall mounted application is not desired or available. For U.S.P.S. approved recessed mounted units, please see our recessed mounted 4C horizontal mailboxes on pages 16-19.



#3916D-20 maximum height free-standing 4C horizontal mailbox unit in aluminum finish displayed

4C

Note: Salsbury 3900 series free-standing 4C horizontal mailboxes include a U.S.P.S. approved 4C horizontal mailbox unit, a matching enclosure and master commercial lock(s) for private access. For access by the U.S. Postal Service, contact your local postmaster for approval.

4C MAILBOX CONFIGURATOR



Access our 4C Configurator at:
www.mailboxes.com/Mailbox-Configurator

Our 4C mailbox configurator will assist in determining the ideal combination of mailboxes and parcel lockers based on your specific requirements. This robust tool also allows you to customize 4C mailbox units and add numbering sequences to drawings. In addition to clear and easy to read elevation line drawings with dimensions, our online mailbox configurator will also provide you with PDF, Word, Excel and AutoCAD drawing files to download for your project. Purchasing products and requesting a quote online is simple and convenient.

SAMPLE FREE-STANDING INSTALLATION

Model displayed: 3916D-15

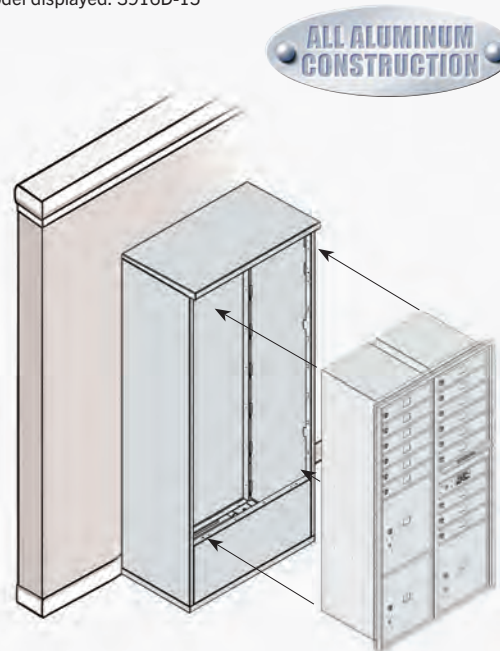

Note: It is recommended that all free-standing 4C horizontal mailbox units be floor and/or wall anchored.

MAXIMUM HEIGHT UNITS - 72-1/8" H

11 DOOR HIGH UNITS - 69-3/8" H



3916D-20



3916D-15



3911D-20



3911D-10

FREE-STANDING 4C HORIZONTAL MAILBOXES - INCLUDES 4C MAILBOX AND ENCLOSURE

MODEL	DESCRIPTION	UNIT SIZE (includes enclosure)	WEIGHT
MAXIMUM HEIGHT UNITS - 72-1/8" H (includes enclosure)			
3916D-20 ¹	20 MB1 Doors and 2 Parcel Lockers (PL4.5's)	31-3/4" W x 72-1/8" H x 18-1/2"D	255 lbs.
3916D-15 ¹	15 MB1 Doors and 3 Parcel Lockers (PL4.5's, PL5)	31-3/4" W x 72-1/8" H x 18-1/2"D	245 lbs.
3916D-10 ¹	10 MB1 Doors and 4 Parcel Lockers (PL4.5's, PL5's)	31-3/4" W x 72-1/8" H x 18-1/2"D	235 lbs.
3916D-6P ¹	6 Parcel Lockers (PL4.5's, PL5's, PL6's)	31-3/4" W x 72-1/8" H x 18-1/2"D	230 lbs.
3916S-09 ¹	9 MB1 Doors and 1 Parcel Locker (PL4.5)	17-3/4" W x 72-1/8" H x 18-1/2"D	145 lbs.
3916S-06 ¹	6 MB1 Doors and 2 Parcel Lockers (PL3, PL4.5)	17-3/4" W x 72-1/8" H x 18-1/2"D	145 lbs.
3916S-3P ¹	3 Parcel Lockers (PL4.5, PL5, PL6)	17-3/4" W x 72-1/8" H x 18-1/2"D	140 lbs.

MAXIMUM HEIGHT UNITS - 72-1/8" H

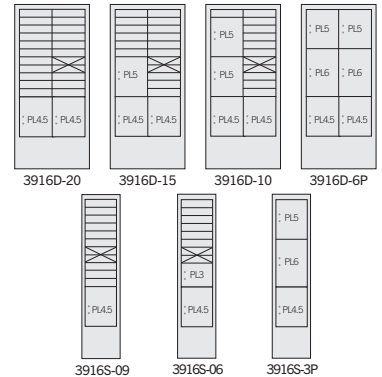

MODEL	DESCRIPTION	UNIT SIZE (includes enclosure)	WEIGHT
11 DOOR HIGH UNITS - 69-3/8" H (includes enclosure)			
3911D-20 ¹	20 MB1 Doors - no Parcel Lockers	31-3/4" W x 69-3/8" H x 18-1/2"D	225 lbs.
3911D-15 ¹	15 MB1 Doors and 1 Parcel Locker (PL5)	31-3/4" W x 69-3/8" H x 18-1/2"D	215 lbs.
3911D-10 ¹	10 MB1 Doors and 2 Parcel Lockers (PL5's)	31-3/4" W x 69-3/8" H x 18-1/2"D	215 lbs.
3911D-4P ¹	4 Parcel Lockers (PL5's, PL6's)	31-3/4" W x 69-3/8" H x 18-1/2"D	210 lbs.
3911S-09 ¹	9 MB1 Doors - no Parcel Lockers	17-3/4" W x 69-3/8" H x 18-1/2"D	130 lbs.
3911S-04 ¹	4 MB1 Doors and 1 Parcel Locker (PL5)	17-3/4" W x 69-3/8" H x 18-1/2"D	130 lbs.
3911S-2P ¹	2 Parcel Lockers (PL5, PL6)	17-3/4" W x 69-3/8" H x 18-1/2"D	120 lbs.

11 DOOR HIGH UNITS - 69-3/8" H

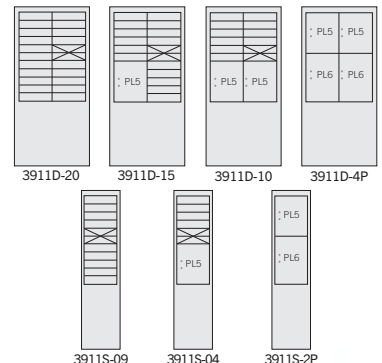

Current Pricing and Volume Discounts Available at Mailboxes.com!

¹ Specify



more free-standing 4C horizontal mailboxes available on pages 26-27 and online

Free-Standing 4C Horizontal Mailboxes

for custom 4C mailbox units and options — see pages 28 - 31

- Ideal for Private Mail Delivery Applications Including Military Bases and Student Housing
- Designed for Applications when Wall Installations are Not Available
- Outgoing Mail Compartment
- Fully Integrated Parcel Locker(s)
- For Indoor or Outdoor Use
- Engraved Doors or Placards Available
- ADA Compliant Units Available  - see page 27 or visit: www.mailboxes.com/ADA-4C-Mailboxes



#3916D-15 maximum height free-standing 4C horizontal mailboxes in bronze finish with optional custom engraved doors - regular (#3768) displayed

4C

Note: Salsbury 3900 series free-standing 4C horizontal mailboxes include a U.S.P.S. approved 4C horizontal mailbox unit, a matching enclosure and master commercial lock(s) for private access. For access by the U.S. Postal Service, contact your local postmaster for approval.

STANDARD FEATURES

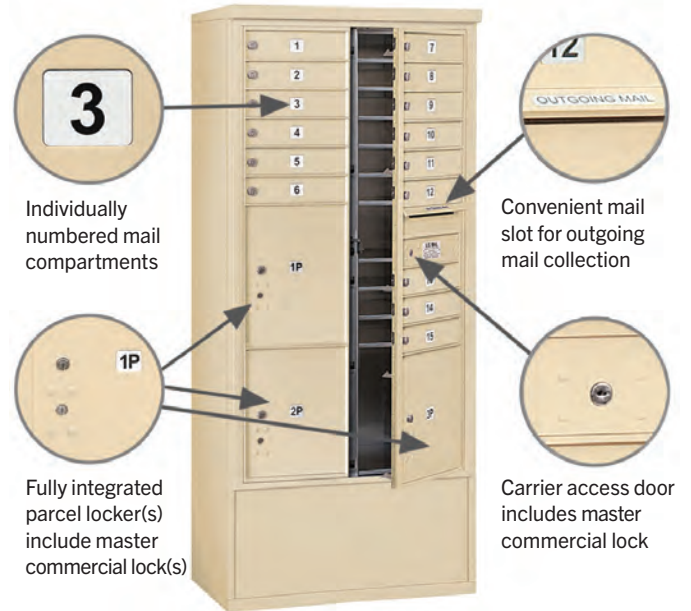

Front views of 3916D-15 in sandstone finish displayed



**ALL ALUMINUM
CONSTRUCTION**

10 DOOR HIGH UNITS* - 52-7/8" H

6 DOOR HIGH UNITS* - 52-7/8" H



3910D-10



3910S-04



3906D-10



3906S-04



* All units meet ADA reach requirements when installed with the tenant locks in the top row of mailboxes no more than 48" above the finished floor and the bottom shelf of the lowest row of mailboxes no less than 28" above the finished floor.

FREE-STANDING 4C HORIZONTAL MAILBOXES - INCLUDES 4C MAILBOX AND ENCLOSURE

MODEL	DESCRIPTION	UNIT SIZE (includes enclosure)	WEIGHT
10 DOOR HIGH UNITS - 52-7/8" H (includes ADA compliant enclosure)			
3910D-10 ¹	10 MB1 Doors and 2 Parcel Lockers (PL4, PL4.5)	31-3/4" W x 52-7/8" H x 18-1/2"D	190 lbs.
3910D-09 ¹	9 MB1 Doors and 2 Parcel Lockers (PL4.5, PL5)	31-3/4" W x 52-7/8" H x 18-1/2"D	190 lbs.
3910D-06 ¹	6 MB1 Doors and 2 Parcel Lockers (PL6's)	31-3/4" W x 52-7/8" H x 18-1/2"D	185 lbs.
3910D-4P ¹	4 Parcel Lockers (PL5's)	31-3/4" W x 52-7/8" H x 18-1/2"D	180 lbs.
3910S-04 ¹	4 MB1 Doors and 1 Parcel Locker (PL4.5)	17-3/4" W x 52-7/8" H x 18-1/2"D	110 lbs.
3910S-03 ¹	3 MB1 Doors and 1 Parcel Locker (PL5)	17-3/4" W x 52-7/8" H x 18-1/2"D	105 lbs.
3910S-2P ¹	2 Parcel Lockers (PL5's)	17-3/4" W x 52-7/8" H x 18-1/2"D	100 lbs.

10 DOOR HIGH UNITS - 52-7/8" H

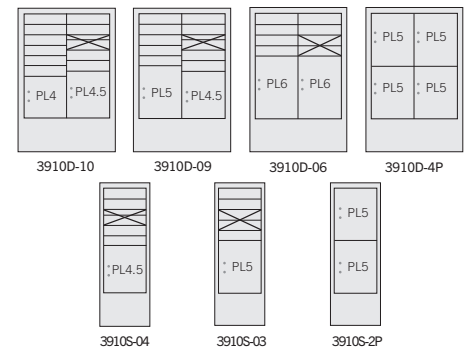

MODEL	DESCRIPTION	UNIT SIZE (includes enclosure)	WEIGHT
6 DOOR HIGH UNITS - 52-7/8" H (includes ADA compliant enclosure)			
3906D-10 ¹	10 MB1 Doors - no Parcel Lockers	31-3/4" W x 52-7/8" H x 18-1/2"D	155 lbs.
3906D-09 ¹	9 MB1 Doors - no Parcel Lockers	31-3/4" W x 52-7/8" H x 18-1/2"D	155 lbs.
3906D-05 ¹	5 MB1 Doors and 1 Parcel Locker (PL5)	31-3/4" W x 52-7/8" H x 18-1/2"D	150 lbs.
3906D-2P ¹	2 Parcel Lockers (PL6's)	31-3/4" W x 52-7/8" H x 18-1/2"D	145 lbs.
3906S-04 ¹	4 MB1 Doors - no Parcel Lockers	17-3/4" W x 52-7/8" H x 18-1/2"D	90 lbs.
3906S-03 ¹	3 MB1 Doors - no Parcel Lockers	17-3/4" W x 52-7/8" H x 18-1/2"D	90 lbs.
3906S-1P ¹	1 Parcel Locker (PL6)	17-3/4" W x 52-7/8" H x 18-1/2"D	85 lbs.

6 DOOR HIGH UNITS - 52-7/8" H

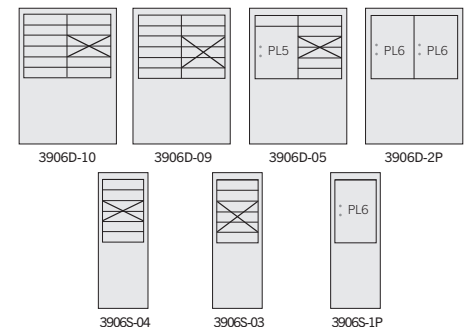

Current Pricing and Volume Discounts Available at Mailboxes.com!

¹ Specify



aluminum



bronze



sandstone



black



OUTGOING MAIL COMPARTMENT

Note: Free-Standing 4C horizontal mailboxes include a compartment for outgoing mail collection that is labeled "Outgoing Mail".

For custom 4C mailbox units, specifications & options - see pages 28-31

Custom 4C Horizontal Mailboxes

for specifications & options - see pages 30 - 31

CUSTOM 4C HORIZONTAL MAILBOXES FRONT OR REAR LOADING

Made of heavy duty aluminum and stainless steel hardware, Salsbury custom 4C horizontal mailboxes and parcel lockers are available as recessed mounted, surface mounted and free standing units in configurations that are one door wide (single column) and two (2) doors wide (double column). Units can be configured with a combination of four (4) mailbox door sizes and five (5) parcel locker door sizes to meet your custom requirements. To customize your unit, access our 4C mailbox configurator online at www.mailboxes.com/Mailbox-Configurator or submit a required layout for a price quotation. Custom 4C horizontal mailboxes feature a durable powder coated finish and are available in a variety of standard colors. Custom colors are also available as an option upon request. Custom 4C horizontal mailboxes are designed for indoor or outdoor use and are ideal for apartments, residential communities, commercial buildings and many other applications.

If Front Loading:

Units include one or two (2) master door(s) that swing(s) on continuous integral hinges. The outgoing mail compartment includes the access door and cannot be used for mail distribution. The rear of the unit incorporates a solid rear cover.

If Rear Loading:

The front of the outgoing mail compartment is comprised of fixed panels (no access door). The rear of the unit incorporates one or two (2) access door(s) with heavy duty latches and continuous hinges. Units are available without rear access doors upon request. Note: Rear loading access is only available for recessed mounted units.

4C

Note: Salsbury custom recessed mounted 4C horizontal mailboxes and parcel lockers are U.S.P.S. approved and meet the specifications of USPS-STD-4C. 4C mailboxes are required for new construction and major renovations. Salsbury custom surface mounted and free-standing units include a U.S.P.S. approved 4C horizontal mailbox, matching enclosure and master commercial locks for private access.



RECESSED MOUNTED
Custom 3700 Series Unit



SURFACE MOUNTED
Custom 3800 Series Unit



FREE-STANDING
Custom 3900 Series Unit



Front view of Custom Front Loading Recessed Mounted Double Column Unit displayed



Rear view of Custom Rear Loading Recessed Mounted Double Column Unit with Rear Access Doors displayed

Access our 4C Mailbox Configurator at:

www.mailboxes.com/Mailbox-Configurator

- Assist in determining the ideal combination of mailboxes and parcel lockers based on requirements
- Customize door configurations within recessed mounted, surface mounted and free-standing units
- Receive dimensional PDF, Word, Excel and AutoCAD drawing files for use in designing, quoting or ordering mailboxes



Customize individual units



Custom engraving available



Custom finishes available



Design multiple elevations

ORDERING CUSTOM 4C HORIZONTAL UNITS

Following simple guidelines, custom units can be configured with a combination of four (4) mailbox door sizes and five (5) parcel locker door sizes.

SAMPLE DOUBLE COLUMN FRONT LOADING UNIT

- 1)** Determine the number of openings required using a combination of mailbox doors and parcel lockers listed below. Custom units can accommodate mailbox doors from 1 high (3-1/4") to 4 high (13-3/4") and parcel locker doors from 3 high (10-1/4") to 6 high (20-3/4").

MAILBOX DOOR SIZES:

- MB1 - 12-3/4" W x 3-1/4" H
- MB2 - 12-3/4" W x 6-3/4" H
- MB3 - 12-3/4" W x 10-1/4" H
- MB4 - 12-3/4" W x 13-3/4" H

PARCEL LOCKER DOOR SIZES:

- PL3 - 12-3/4" W x 10-1/4" H
- PL4 - 12-3/4" W x 13-3/4" H
- PL4.5 - 12-3/4" W x 15-1/2" H
- PL5 - 12-3/4" W x 17-1/4" H
- PL6 - 12-3/4" W x 20-3/4" H

- 2)** Configure your requirements into a one wide (single column) or two wide (double column) unit and into equivalent standard mailbox door heights. The outgoing mail compartment / carrier access door must be situated between 36" and 48" above the finished floor (AFF). To customize the maximum height units, please access our 4C configurator at www.mailboxes.com/Mailbox-Configurator or contact our design engineers for layout, options and pricing.

- 3)** Specify the installation type:



Recessed mounted
3700 Series
4C Horizontal
Mailboxes



Surface mounted
3800 Series
4C Horizontal
Mailboxes

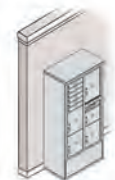

Free-standing
3900 Series
4C Horizontal
Mailboxes

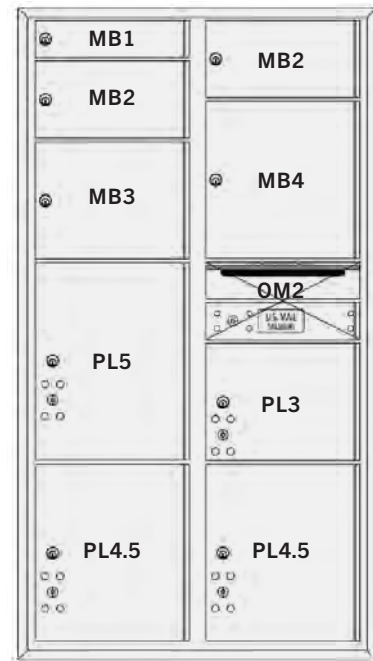

Note: U.S.P.S. standard 4C requires a minimum of one parcel locker for every five (5) tenant compartments. Parcel lockers are not required for installation sites with less than five (5) tenant compartments.

CUSTOM 4C HORIZONTAL INFORMATION FOR RECESSED MOUNTED UNITS

Note: Access our 4C Configurator for surface mounted and free-standing mailbox unit pricing

MODEL	DESCRIPTION	DOOR SIZE
MAILBOXES		
3700MB1 ^{1,2,3}	MB1 Door and 15" D Compartment	12-3/4" W x 3-1/4" H
3700MB2 ^{1,2,3}	MB2 Door and 15" D Compartment	12-3/4" W x 6-3/4" H
3700MB3 ^{1,2,3}	MB3 Door and 15" D Compartment	12-3/4" W x 10-1/4" H
3700MB4 ^{1,2,3}	MB4 Door and 15" D Compartment	12-3/4" W x 13-3/4" H
PARCEL LOCKERS		
3700PL3 ^{1,2,3}	PL3 Parcel Locker and 15" D Compartment	12-3/4" W x 10-1/4" H
3700PL4 ^{1,2,3}	PL4 Parcel Locker and 15" D Compartment	12-3/4" W x 13-3/4" H
3700PL4.5 ^{1,2,3}	PL4.5 Parcel Locker and 15" D Compartment	12-3/4" W x 15-1/2" H
3700PL5 ^{1,2,3}	PL5 Parcel Locker and 15" D Compartment	12-3/4" W x 17-1/4" H
3700PL6 ^{1,2,3}	PL6 Parcel Locker and 15" D Compartment	12-3/4" W x 20-3/4" H
OUTGOING MAIL COMPARTMENTS / CARRIER ACCESS DOORS		
3700OM2 ^{1,2,3}	OM2 Outgoing Mail Compartment / Carrier Access Doors*	12-3/4" W x 6-3/4" H
3700OM3 ^{1,2,3}	OM3 Outgoing Mail Compartment / Carrier Access Doors*	12-3/4" W x 10-1/2" H
3700CA ^{1,2,3}	Carrier Access Door*	12-3/4" W x 3-1/4" H
SPARE PARTS / OPTIONS		
3751 ¹	Door - MB1 replacement door and lock with (3) keys	12-3/4" W x 3-1/4" H
3752 ¹	Door - MB2 replacement door and lock with (3) keys	12-3/4" W x 6-3/4" H
3753 ¹	Door - MB3 replacement door and lock with (3) keys	12-3/4" W x 10-1/4" H
3754 ¹	Door - MB4 replacement door and lock with (3) keys	12-3/4" W x 13-3/4" H
3766	Custom finish (minimum order of (100) doors) - specify color - see color options at: www.mailboxes.com/4c-custom-horizontal-mailboxes	
3767	Custom engraved placard - for 4C horizontal mailbox doors and parcel lockers	
3768	Custom engraved door - regular - for 4C horizontal mailbox doors and parcel lockers	
3774	Custom engraved door - black filled - for 4C horizontal mailbox doors and parcel lockers	
3775	Master commercial lock - factory installed for private access on FL units and PL's - with (2) keys	
3776	Tenant parcel locker lock - with (3) keys	

* The Outgoing Mail Compartment / Carrier Access Door must be situated between 36" and 48" above the finished floor (AFF).

- ¹ Specify - aluminum, bronze, sandstone or black finishes are available for recessed mounted, surface mounted and free-standing mailbox units.
- ² Specify - front loading (FL) or rear loading (RL)
- ³ Specify - U.S.P.S. access or private access (order #3775 master commercial lock for private access on FL units and PL's)

Note: The price of custom 4C horizontal mailboxes is the total of each mailbox, parcel locker, master commercial lock and outgoing mail compartment within a unit plus enclosures (for 3800 and 3900 units) if necessary. Allow approximately 3-4 weeks production time for custom 4C horizontal mailboxes. For faster service, see pages 16-27 for standard configurations.

4C Horizontal Mailbox Specifications & Options

see 4C horizontal mailbox units on pages 16 - 29

- Manufactured by Salsbury Industries to USPS-STD-4C Specifications
- 4C Recessed Mounted Mailboxes are Required for New Construction and Major Renovations
- For Indoor or Outdoor Use
- Fully Integrated or Stand-Alone Parcel Lockers
- ADA Compliant Units Available 
 - see pages 19, 23 and 27 or visit: www.mailboxes.com/ADA-4C-Mailboxes



Current Pricing and Volume Discounts Available at Mailboxes.com!



Custom recessed mounted 4C horizontal mailboxes in aluminum finish with optional custom engraved doors - black filled (#3774) displayed

4C

Note: Salsbury custom recessed mounted 4C horizontal mailboxes and parcel lockers are U.S.P.S. approved and meet the specifications of USPS-STD-4C. 4C mailboxes are required for new construction and major renovations. Salsbury custom surface mounted and free-standing units include a U.S.P.S. approved 4C horizontal mailbox, matching enclosure and master commercial locks for private access.

4C MAILBOX CONFIGURATOR



Access our 4C Configurator at:
www.mailboxes.com/Mailbox-Configurator

Our 4C mailbox configurator will assist in determining the ideal combination of mailboxes and parcel lockers based on your specific requirements. This robust tool also allows you to customize 4C mailbox units and add numbering sequences to drawings. In addition to clear and easy to read elevation line drawings with dimensions, our online mailbox configurator will also provide you with PDF, Word, Excel and AutoCAD drawing files to download for your project. Purchasing products and requesting a quote online is simple and convenient.

DESIGN ASSISTANCE

Our design engineers are available to architects, specification writers and individuals involved in the design of mail distribution facilities, apartment complexes and commercial buildings. Visit the informative Architect Resources section of our website at: www.mailboxes.com/Architectural-Resources to download specifications, technical drawings, AutoCAD, BIM/Revit models and Augmented Reality (AR) models. You can also submit required layout and options for a price quotation.

Front loading units include one or two (2) master door(s) that swing(s) on continuous integral hinges. The outgoing mail compartment includes the access door and cannot be used for mail distribution. The rear of the unit incorporates a solid rear cover. Note: U.S.P.S. standard 4C requires a minimum of one parcel locker for every five (5) tenant compartments. Parcel lockers are not required for installation sites with less than five (5) tenant compartments.

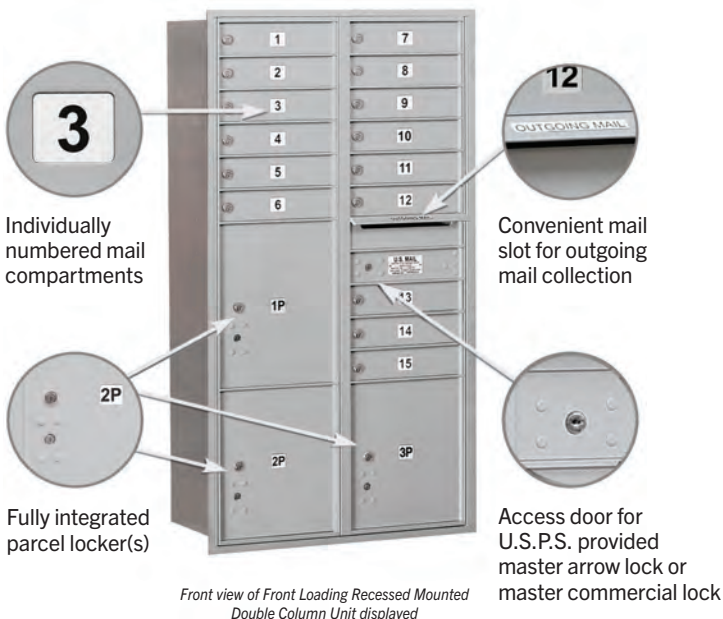

Front view of Front Loading Recessed Mounted Double Column Unit displayed

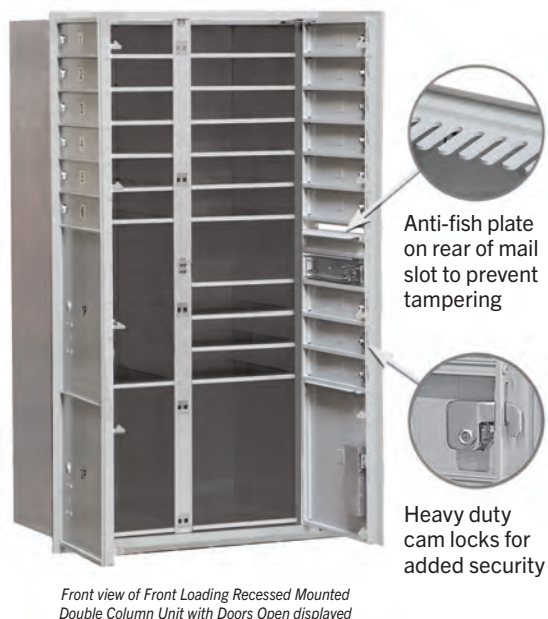

Front view of Front Loading Recessed Mounted Double Column Unit with Doors Open displayed

4C HORIZONTAL MAILBOX SPECIFICATIONS & OPTIONS

FOR RECESSED MOUNTED, SURFACE MOUNTED AND FREE-STANDING MAILBOX UNITS

MAILBOX DOOR SIZES

Each aluminum door includes a heavy duty five (5) pin cylinder cam lock with a dust/rain shield and three (3) keys.

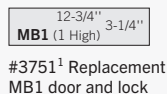

#3751¹ Replacement MB1 door and lock

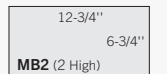

#3752¹ Replacement MB2 door and lock

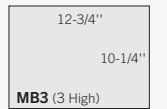

#3753¹ Replacement MB3 door and lock

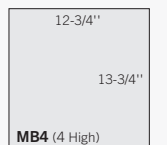

#3754¹ Replacement MB4 door and lock

PARCEL LOCKER DOOR SIZES

Parcel lockers offer tenants a convenient way to receive packages on site and are fit with a two (2) key security system.

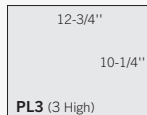

#3753P¹ Replacement PL3 door and lock

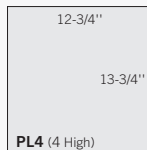

#3754P¹ Replacement PL4 door and lock

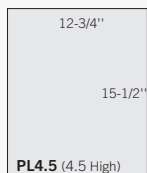

#3754.5P¹ Replacement PL4.5 door and lock

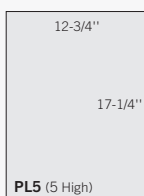

#3755P¹ Replacement PL5 door and lock



#3756P¹ Replacement PL6 door and lock

¹ Specify



FINISHES

The durable and corrosion resistant 4C units feature a durable powder coated finish available in aluminum, bronze, sandstone or black. Custom finishes (#3766) are available as an option upon request – minimum order of (100) doors.

DOOR IDENTIFICATION

Each standard 4C horizontal mailbox door has a 1" high number. The outgoing mail compartment is labeled "Outgoing Mail" and the parcel locker(s) are labeled with a "1P", "2P", etc. Custom identification systems are available as an option upon request.

CUSTOM ENGRAVED PLACARDS

1-3/4" W x 1-1/2" H custom engraved self-adhesive placards are available as an option upon request. (#3767)



#3767

OUTGOING MAIL COMPARTMENTS

One compartment in each unit is labeled "Outgoing Mail" and includes a weather protection flap and a 11-3/4" W x 3/4" H mail slot.

LOCKS

Each 4C mailbox door includes a heavy duty five (5) pin cylinder cam lock with a dust/rain shield and three (3) keys (2,000 different key changes). (#3790-5 - set of (5) #3790 locks)

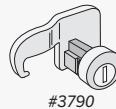

#3790

- Additional keys per lock when ordering (#3798)
- Key blanks - box of (50) (#3799)
- Custom lock installation - cylinders provided by owner (for installations not serviced by the U.S.P.S.) (100 door minimum) (#3793)

For installations NOT serviced by the U.S.P.S.

- Mail slots (#3769)
- Standard slot size: 10-3/4" W x 3/4" H
- Custom slot sizes are available upon request.
- Plexiglass window 1-1/8" W x 7/8" H (#3771)
- Outgoing mail slot plug kit (#3770)



#3769

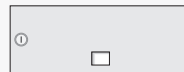

#3771

CUSTOM ENGRAVED DOORS

- Custom engraved door – regular (#3768)
- Custom engraved door – black filled (#3774)



#3768



#3774

MASTER COMMERCIAL LOCK

Factory installed if for private access - for front loading mailboxes and parcel lockers - with (2) keys (#3775)

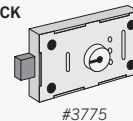

#3775

TENANT PARCEL LOCKER LOCK

For parcel locker door - with (3) keys (#3776)

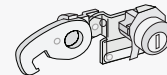

#3776

COMBINATION LOCK

Three (3) digit single dial combination lock with spring latch and automatic throw-off (for installations not serviced by the U.S.P.S.). Combination numbers can be changed by owner. (#3786)

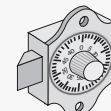

#3786

Standard 4B+ Horizontal Mailboxes

STANDARD 4B+ HORIZONTAL MAILBOXES

FRONT LOADING 

Made entirely of aluminum, Salsbury 3600 series U.S.P.S. approved standard 4B+ horizontal mailboxes are available in units with standard A doors and larger B doors. Units with standard A doors are available in 3, 4 or 5 doors wide and 5, 6 or 7 doors high. Units with larger B doors are available in 2 doors wide and 5, 6 or 7 doors high. Each aluminum door includes a five (5) pin cylinder cam lock with two (2) keys and a 2" W x 5/8" H clear plastic card holder (card included) to identify the tenant's name and/or box number. The mailbox compartments are made of sheet aluminum. Custom engraved placards (#3667) are available as an option upon request. Standard 4B+ horizontal mailboxes feature a durable powder coated finish available in three (3) contemporary colors and are ideal for apartments, condominiums, commercial buildings, colleges and schools and many other applications.

**Current Pricing and Volume Discounts
Available at Mailboxes.com!**



#3614's in aluminum finish displayed

4B+

Note: Salsbury 3600 series standard 4B+ horizontal mailboxes are U.S.P.S. approved to the required security upgrades of USPS-STD-4B+. These mailboxes are approved for replacement and/or retrofit installations. For new construction and major renovations, see 4C horizontal mailboxes on pages 16-31.



#3621's in bronze finish with optional custom engraved doors - regular (#3668) displayed

SAMPLE INSTALLATION

Model displayed:
(2) 3635 Front
Loading Units

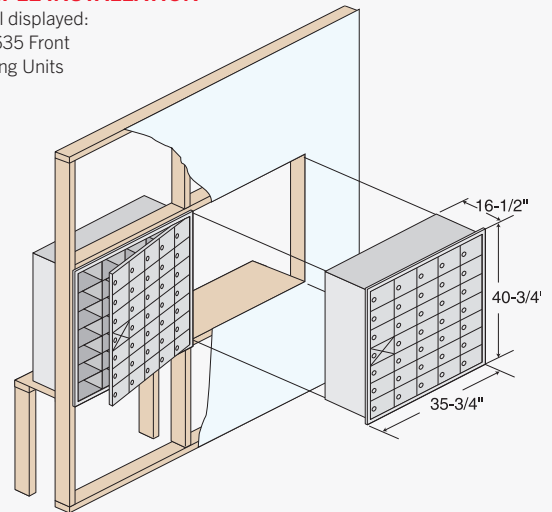

Note: For U.S.P.S. serviced installations, the tenant locks in the top row of mailboxes must be no more than 67" above the finished floor and the bottom of the lowest row must be no less than 28" above the finished floor.

**ALL ALUMINUM
CONSTRUCTION**

Front loading units include a door panel that swings on a continuous hinge. One mailbox opening is required for a master postal or commercial lock and cannot be used for mail distribution. Units include factory installed 3/4" W x 1/4" D trim and a solid rear cover.



3628
28 Front Loading
A doors (27 usable)



3635
35 Front Loading
A doors (34 usable)



3614
14 Front Loading
B doors (13 usable)

STANDARD 4B+ HORIZONTAL MAILBOXES - FRONT LOADING - U.S.P.S. APPROVED

MODEL	DESCRIPTION	UNIT SIZE (includes trim)	WEIGHT
7 DOOR HIGH UNITS - 40-3/4" H			
3621 ^{1,2}	21 A Doors (20 usable on FL)	22-3/4" W x 40-3/4" H x 16-1/2" D	70 lbs.
3628 ^{1,2}	28 A Doors (27 usable on FL)	29-1/4" W x 40-3/4" H x 16-1/2" D	85 lbs.
3635 ^{1,2}	35 A Doors (34 usable on FL)	35-3/4" W x 40-3/4" H x 16-1/2" D	100 lbs.
3614 ^{1,2}	14 B Doors (13 usable on FL)	29-1/4" W x 40-3/4" H x 16-1/2" D	85 lbs.
6 DOOR HIGH UNITS - 35-1/4" H			
3618 ^{1,2}	18 A Doors (17 usable on FL)	22-3/4" W x 35-1/4" H x 16-1/2" D	60 lbs.
3624 ^{1,2}	24 A Doors (23 usable on FL)	29-1/4" W x 35-1/4" H x 16-1/2" D	75 lbs.
3630 ^{1,2}	30 A Doors (29 usable on FL)	35-3/4" W x 35-1/4" H x 16-1/2" D	90 lbs.
3612 ^{1,2}	12 B Doors (11 usable on FL)	29-1/4" W x 35-1/4" H x 16-1/2" D	75 lbs.
5 DOOR HIGH UNITS - 29-3/4" H			
3615 ^{1,2}	15 A Doors (14 usable on FL)	22-3/4" W x 29-3/4" H x 16-1/2" D	55 lbs.
3620 ^{1,2}	20 A Doors (19 usable on FL)	29-1/4" W x 29-3/4" H x 16-1/2" D	65 lbs.
3625 ^{1,2}	25 A Doors (24 usable on FL)	35-3/4" W x 29-3/4" H x 16-1/2" D	75 lbs.
3610 ^{1,2}	10 B Doors (9 usable on FL)	29-1/4" W x 29-3/4" H x 16-1/2" D	65 lbs.

- 3668 Custom engraved door - regular - for 3600 series mailbox doors and parcel lockers
- 3674 Custom engraved door - black filled - for 3600 series mailbox doors and parcel lockers
- 3675 Master commercial lock - factory installed if for private access - for FL mailboxes - with (2) keys
- 3686 Combination lock - 3 digit spring latch - additional per door - for installations not serviced by the U.S.P.S.
- 3690-5 Set of (5) #3690 locks - standard replacement for 3600 series doors - with (2) keys
- 3699 Key blanks - for standard 3600 series locks - box of (50)



ACCESS DOOR
On 3600 series front loading horizontal mailboxes, one opening per unit is required for a master postal or commercial lock and cannot be used for mail distribution.

STANDARD FRONT LOADING CONFIGURATIONS

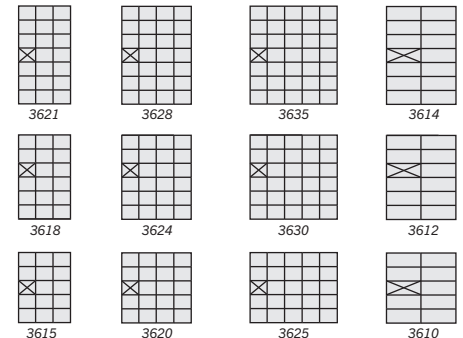

3600 SERIES DOOR SIZES

6-1/2" x 5-1/4" **A**

#3651¹
Replacement "A" door and lock

13" x 5-1/4" **B**

#3652¹
Replacement "B" door and lock

STANDARD 4B+ HORIZONTAL MAILBOX OPTIONS

- Each mailbox door includes a five (5) pin cylinder cam lock with two (2) keys (1,000 different key changes).
- Lock - for 3600 series (#3690-5 - set of (5) #3690 locks)
 - Additional keys per lock when ordering (#3698)
 - Key blanks - box of (50) (#3699)

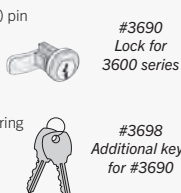

- Master commercial lock - with (2) keys - factory installed if for private access - for front loading mailboxes (#3675)
- Card holder - clear plastic - card and metal insert included (#3697)
- Self-adhesive numbers - sheets of (100) (#3695)
- 4B+ Master door security retrofit kit (#3696)

¹ Specify



aluminum



bronze



sandstone

² Specify - U.S.P.S. access or private access (order #3675 master commercial lock for private access on FL units and PL's)

DOOR AND COMPARTMENT IDENTIFICATION

Each mailbox door includes a 2" W x 5/8" H clear plastic card holder (#3697) to identify the tenant's name and/or box number. Self-adhesive numbers (1-3000 available) are supplied upon request with a standard order. Custom identification systems are available as an option upon request. Label holders (#1070) neatly organize and identify the front/rear of the mailbox compartments and are available as an option upon request.

- Custom engraved placards - 2" W x 5/8" H (#3667)
- Custom engraved door - regular (door will be solid - no card holder) (#3668)
- Custom engraved door - black filled (door will be solid - no card holder) (#3674)

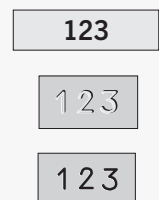



3503



3504



3505



3506



3507

VERTICAL MAILBOXES - FRONT LOADING - U.S.P.S. APPROVED

MODEL	DESCRIPTION	UNIT SIZE	WEIGHT
3503 ^{1,2,3}	3 Doors	18-3/4" W x 19" H x 7-1/2" D	25 lbs.
3504 ^{1,2,3}	4 Doors	24-1/4" W x 19" H x 7-1/2" D	30 lbs.
3505 ^{1,2,3}	5 Doors	29-3/4" W x 19" H x 7-1/2" D	35 lbs.
3506 ^{1,2,3}	6 Doors	35-1/4" W x 19" H x 7-1/2" D	40 lbs.
3507 ^{1,2,3}	7 Doors	40-3/4" W x 19" H x 7-1/2" D	45 lbs.
3575	Master commercial lock - factory installed if for private access - with (2) keys		
3590-5	Set of (5) #3590 locks - standard replacement for 3500 series doors - with (2) keys		
3599	Key blanks - for standard 3500 series locks - box of (50)		
2240 ^{1,4}	Letter Box - surface mounted	15" W x 19" H x 7-1/2" D	20 lbs.
2245 ^{1,4}	Letter Box - recessed mounted	15" W x 19" H x 6-3/4" D	20 lbs.
2246	Master commercial lock - factory installed if for private access - with (2) keys		

LETTER BOXES USPS or PRIVATE ACCESS

A letter box is an ideal way to collect outgoing mail or other correspondence. See pages 40-41 for additional products and specifications.

CUSTOM ENGRAVING (OPTION - #2266)

Custom engraving for letter boxes (specify regular or black filled) is available as an option upon request. See page 41 for specifications.

OUTGOING MAIL SLOT (OPTION - #3569)

A 4-3/8" W x 1/2" H outgoing mail slot is available as an option upon request. It will be located in the far left door of the unit unless otherwise specified. If a mail slot is requested, order unit with one additional compartment than the total number of tenants receiving mail.

CUSTOM ENGRAVED PLACARDS (OPTION - #3567)

2-1/2" W x 5/8" H custom engraved self-adhesive placards are available as an option upon request.

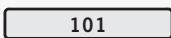

2240

- ¹ Specify aluminum
- bronze
- sandstone

- ² Specify - surface mounted or recessed mounted
- ³ Specify - U.S.P.S. access or private access (order master commercial lock #3575)
- ⁴ Specify - U.S.P.S. access or private access (order master commercial lock #2246)

Aluminum Mailboxes - Standard System

continued on pages 38 - 39

STANDARD SYSTEM

REAR LOADING PRIVATE ACCESS

Salsbury 2200 series standard system aluminum mailboxes have 1/4" thick extruded aluminum doors with a durable powder coated aluminum finish. Each door includes a five (5) pin cylinder cam lock with two (2) keys. Standard system aluminum mailbox units are designed to stack two (2) high and mount adjacent to each other or between wall studs. All units have the same outside dimensions. Alternative locking systems are available - see aluminum mailbox options on page 39. The mailbox compartments have open backs (hinged locking rear covers #2250 are available as an option upon request) and are constructed of 20 gauge steel. Standard system aluminum mailboxes are ideal for use in colleges and schools, private postal centers, government agencies, corporate mailrooms, military bases, police stations and many other applications.

Current Pricing and Volume Discounts Available at Mailboxes.com!



2200 SERIES STANDARD SYSTEM DOOR SIZES

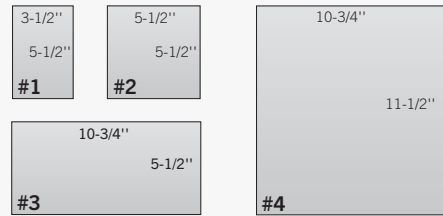

ALUMINUM DOORS

Top view of #1 aluminum door, lock and hinge

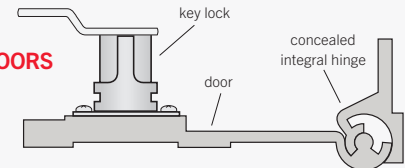

SAMPLE INSTALLATION

Models displayed:

- (3) 2230's
- (3) 2218's

Allow approximately 24" W and 60" H for each mailbox column.

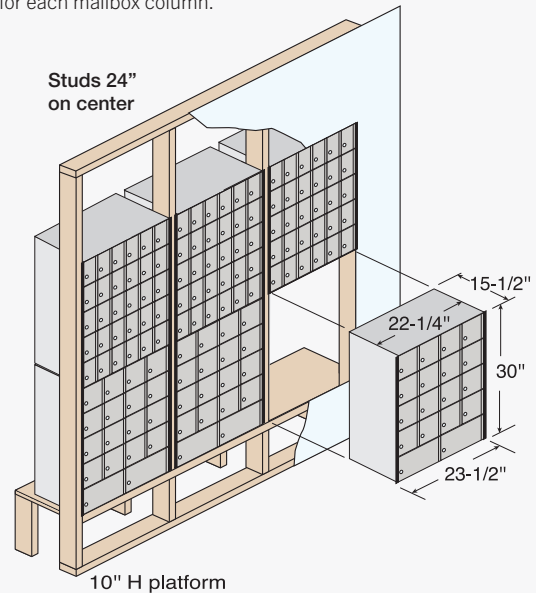

Standard system aluminum mailboxes with optional engraved doors (#2268) displayed



2230



2220



2218



2214



2210



2206

STANDARD SYSTEM - REAR LOADING

MODEL	DESCRIPTION	DOOR SIZE	WEIGHT
UNIT SIZE: 23-1/2" W x 30" H x 15-1/2" D			
2230	30 Doors	3-1/2" W x 5-1/2" H	100 lbs.
2220	20 Doors	5-1/2" W x 5-1/2" H	90 lbs.
2218	18 Doors	(16) 5-1/2" W x 5-1/2" H	90 lbs.
		(2) 10-3/4" W x 5-1/2" H	
2214	14 Doors	(12) 5-1/2" W x 5-1/2" H	85 lbs.
		(2) 10-3/4" W x 11-1/2" H	
2210	10 Doors	10-3/4" W x 5-1/2" H	85 lbs.
2206	6 Doors	(2) 10-3/4" W x 5-1/2" H	70 lbs.
		(4) 10-3/4" W x 11-1/2" H	
2213	Trim - black - for up to (3) columns of mailboxes		10 lbs.
2286	Lock - combination for each 2200 series door		
2290-5	Set of (5) #2290 locks - standard replacement for 2200 series doors - with (2) keys		
2299	Key blanks - for standard 2200 series locks - box of (50)		



Standard system aluminum mailboxes (#2230) with optional combination locks (#2286) and custom engraved placards (#2267) displayed

Rear view of unit with optional locking rear cover (#2250) displayed

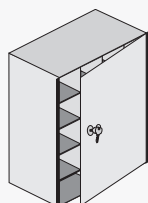

CUSTOM ENGRAVED PLACARDS

7/8" W x 3" H custom engraved self-adhesive placards are available as an option upon request. (#2267)



#2267

CUSTOM DOOR ENGRAVING

Custom door engraving is available as an option upon request.

- Custom engraved door - regular (#2268)
- Custom engraved door - black filled (#2274)



#2268

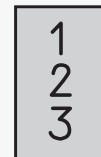

#2274

See aluminum mailbox options on page 39

Aluminum Mailboxes - Rack Ladder System

RACK LADDER SYSTEM

REAR LOADING PRIVATE ACCESS R

Salsbury 2200 series rack ladder system aluminum mailboxes have 1/4" thick extruded aluminum doors with a durable powder coated aluminum finish. Each door includes a five (5) pin cylinder cam lock with two (2) keys. The mailbox compartments have open backs (rear covers for a column of rack ladder mailboxes #2251 and for individual rack ladder mailboxes #2252 are available as options upon request) and are constructed of 20 gauge steel. All units have the same outside dimensions. Rack ladder system aluminum mailbox units are designed to be installed between rack ladders (#2200). The rack ladders support five (5) mailbox units to form a column of mailboxes.

Current Pricing and Volume Discounts Available at Mailboxes.com!

2200 SERIES RACK LADDER SYSTEM DOOR SIZES

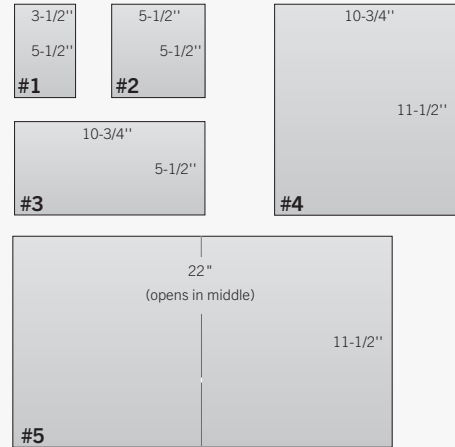

ALUMINUM DOORS

Top view of #1 aluminum door, lock and hinge

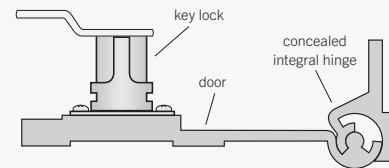

Rack ladder system mailboxes with optional trim (#2213) and optional custom engraved doors-black filled (#2274) displayed



2212



2208



2204



2202



2201

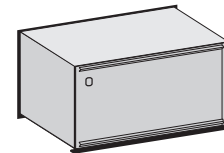

Individual rack ladder mailbox with optional hinged locking rear cover (#2252) displayed

RACK LADDER SYSTEM MAILBOXES - REAR LOADING

MODEL	DESCRIPTION	DOOR SIZE	WEIGHT
UNIT SIZE: 23-1/4" W x 12-1/8" H x 15-1/2" D			
2212	12 Doors	3-1/2" W x 5-1/2" H	45 lbs.
2208	8 Doors	5-1/2" W x 5-1/2" H	40 lbs.
2204	4 Doors	10-3/4" W x 5-1/2" H	35 lbs.
2202	2 Doors	10-3/4" W x 11-1/2" H	35 lbs.
2201	1 Door	22" W x 11-1/2" H	35 lbs.
2200	Rack Ladder	61-7/8" H x 15-1/2" D	25 lbs.
2213	Trim - black - for up to (3) columns of mailboxes		10 lbs.
2286	Lock - combination for each 2200 series door		
2290-5	Set of (5) #2290 locks - standard replacement for 2200 series doors - with (2) keys		
2299	Keys blanks - for standard 2200 series locks - box of (50)		

SAMPLE INSTALLATION

Models displayed:

- (9) 2212's
- (3) 2208's
- (3) 2204's
- (4) 2200's

Units are secured from the rear by brackets (not pictured).

Allow approximately 24" W and 62" H for each mailbox column.

One column of mailbox units requires two (2) rack ladders and each additional column in the same configuration requires one additional rack ladder.

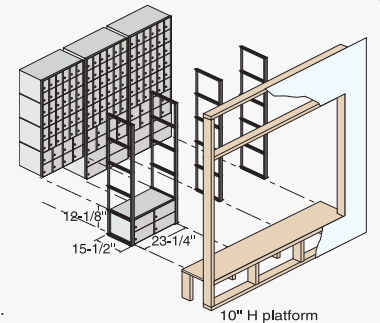

ALUMINUM MAILBOX OPTIONS - FOR STANDARD AND RACK LADDER SYSTEMS (pages 36-39)

OPTIONS

- Custom rack ladders for varied column heights (specify 2, 3, 4 or 6 high columns) (#2200C)
- Rear covers
 - locking on standard system mailboxes (#2250)
 - hasp on rack ladder system columns (#2251)
 - locking on individual rack ladder system mailboxes (#2252)
- Trim - black snap-on peripheral trim 1-1/2" W x 3/8" D for up to three (3) columns of mailboxes (#2213)
- Plexiglass window (#2271)

- Mail slots (#2269)
- Standard mail slot sizes for 2200 series:
 - #1 Door - 2-1/2" W x 3/4" H
 - #2 Door - 4" W x 3/4" H
 - #3 Door - 9" W x 3/4" H
 - #4 Door - 9" W x 3/4" H
 - #5 Door - 9" W x 3/4" H (on left side)
- Custom door finish as specified (#2264)
 - minimum order of 100 doors
- Engraved placards (#2267)
- Engraved door - regular (#2268)
- Engraved door - black filled (#2274)
- Self-adhesive numbers - sheets of (100) (#2295)
- Label holders - (50) 3" W x 3/8" H (#1070)



Custom slot sizes are available upon request.

#2213 Trim

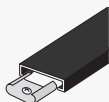

#2271 Plexiglass window 7/8" W x 1-1/4" H



#2268 Sample door engraving - regular

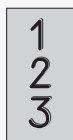

#2274 Sample door engraving - black filled

DOOR AND COMPARTMENT IDENTIFICATION

Self-adhesive numbers (1-3000 available) are supplied upon request with a standard order. Custom identification systems are available as an option upon request. Label holders (#1070) neatly organize and identify the rear of the mailbox compartments and are available as an option upon request.

LOCKS

- Each mailbox door includes a five (5) pin cylinder cam lock with two (2) keys (2,000 different key changes).
- Lock - for 2200 set of (5) #2290 (#2290-5)
- Three (3) digit single dial combination lock with spring latch and automatic throw-off (#2286) (combination numbers can be changed by owner)
- Thumb latch - in lieu of standard lock (#2289)
- Spring latch lock with two (2) keys - not pictured (#2287)
- Custom lock installation
 - cylinders provided by owner - (100) door minimum (#2293)
- Key blanks - box of (50) - for 2200 series (#2299)

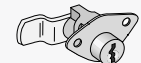

#2290 Lock for 2200 series

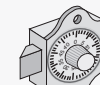

#2286 Combination lock



#2289 Thumb latch



#2298 Additional keys for #2290

Letter Boxes

LETTER BOXES

Made of sheet and extruded aluminum, Salsbury letter boxes are available in a standard size (#2240 and #2245) and a slim size (#2260 and #2265). Both sizes are available as surface mounted or recessed mounted units. Standard and slim letter boxes feature a durable powder coated finish available in three (3) contemporary colors. The doors are constructed of heavy duty 1/4" thick aluminum and are accessed from the front. Custom engraving (#2266) and plexiglass windows (#2273) are available as options upon request. Standard letter boxes are ideal for apartments, condominiums, commercial buildings, offices and many other applications.

Current Pricing and Volume Discounts Available at Mailboxes.com!

SAMPLE INSTALLATION

Models displayed:
(1) 2240
(1) 2245

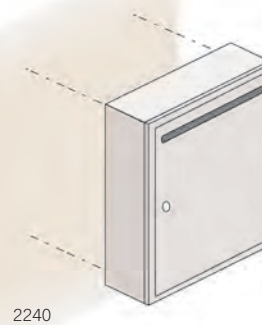

2240

SURFACE MOUNTED

Surface mounted units mount directly to a flat surface and are secured with mounting hardware (not included) through the back panel.

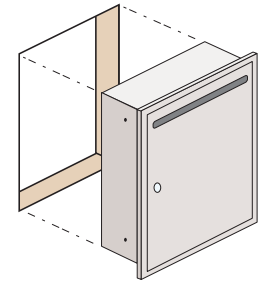

2245

RECESSED MOUNTED

Recessed mounted units fit into a rough opening and are secured with mounting hardware (not included) through the back or side panels. A fully integrated 3/4" flanged collar fits over the rough opening.

Note: Sample installation also applies to #2260 and #2265



#2245 recessed letter boxes in aluminum finish and #2255 mail drops in aluminum finish (see pages 42-43) with optional custom engraving - black filled (#2266) displayed

SURFACE MOUNTED



2240



2260

RECESSED MOUNTED



2245



2265

DESCRIPTION

2240^{1,2} - Surface Mounted Letter Box - Standard

UNIT SIZE

15" W x 19" H x 7-1/2" D

Mail slot: 11-1/2" W x 3/4" H

WEIGHT

20 lbs.

DESCRIPTION

2260¹ - Surface Mounted Letter Box - Slim

UNIT SIZE

11" W x 19" H x 3-3/4" D

Mail slot: 7-1/2" W x 3/4" H

WEIGHT

15 lbs.

DESCRIPTION

2245^{1,2} - Recessed Mounted Letter Box - Standard

UNIT SIZE

15" W x 19" H x 6-3/4" D

Rough opening:
13-3/4" W x 17-3/4" H x 6-3/4" D

Mail slot: 11-1/2" W x 3/4" H

WEIGHT

20 lbs.

DESCRIPTION

2265¹ - Recessed Mounted Letter Box - Slim

UNIT SIZE

11" W x 19" H x 3-1/2" D

Rough opening:
9-1/2" W x 17-3/4" H x 3-1/2" D

Mail slot: 7-1/2" W x 3/4" H

WEIGHT

15 lbs.

¹ Specify

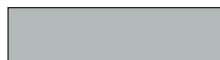

aluminum



bronze

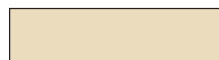

sandstone



² Specify

- For U.S.P.S. access
- For private access (order commercial lock #2246 for #2240 and #2245)

Note: #2260 and #2265 are available in private access only and include a commercial lock.



#2240 surface mounted unit in bronze finish displayed

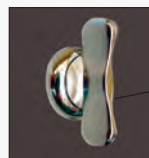

MAIL SLOT (STANDARD)

Standard letter boxes feature an 11-1/2" W x 3/4" H mail slot. Slim letter boxes feature a 7-1/2" W x 3/4" H mail slot. Doors are available without slots as an option upon request.

CUSTOM SLOT (OPTION - #2249)

Slot sizes as specified can be customized to meet your requirements.

CUSTOM ENGRAVING (OPTION - #2266)

Custom engraving (specify regular or black filled) is available as an option upon request. Examples are: OUTGOING MAIL, MAIL, U.S. MAIL, PAYMENTS, LETTERS, KEYS, SUGGESTION BOX, OFFICE, RENT DROP or as specified.

PLEXIGLASS WINDOW (OPTION - #2273)

A 2" W x 10" H plexiglass window is available as an option upon request. This option should not be ordered for units serviced by the U.S.P.S.

COMMERCIAL LOCK (OPTION - #2246)

A private access commercial lock with two (2) keys is available as an option for #2240 and #2245 upon request.

THUMB LATCH (OPTION - #2288)

A non-locking thumb latch is available as an option upon request.

Mail Drops & Receptacles

MAIL DROPS PRIVATE access

Constructed of 1/4" thick aluminum plate and 20 gauge steel, Salsbury recessed mounted mail drops feature a spring-loaded mail flap and an adjustable mail flap stop. Mail drops also feature a durable powder coated finish available in three (3) contemporary colors. Custom engraving (#2266) is available as an option upon request. An optional receptacle (#2256 - see page 43 - order separately) aligns with the mail drop chute for receipt of deliveries. Mail drops are ideal for collecting documents and small packages and may be used for U.S.P.S. residential door mail delivery.

Current Pricing and Volume Discounts Available at Mailboxes.com!



#2255 in aluminum finish with optional custom engraving - black filled (#2266) displayed



#2255 with optional custom engraving - regular (#2266) displayed

CUSTOM ENGRAVING (OPTION - #2266)
Custom engraving (specify regular or black filled) is available as an option upon request. Examples are: MAIL, PAYMENTS, OUTGOING MAIL, LETTERS, KEYS, SUGGESTION BOX, OFFICE, RENT DROP or as specified.

#2255 with optional custom engraving - black filled (#2266) displayed

MAIL SLOT (STANDARD)
Mail drops feature an 11" W x 4" H mail slot.

CHUTE (STANDARD)
Attached to each mail drop is a 11-3/4" W x 5" H x 6-1/4" D chute angled at 25°.

ADJUSTABLE MAIL FLAP STOP (STANDARD)
Attached to the inside of each mail drop chute is an adjustable mail flap stop that can limit the size of the mail flap opening.

side view

DESCRIPTION
2255¹ - Mail Drop

UNIT SIZE
14" W x 7" H x 6" D
• Rough opening: 12-1/4" W x 5-1/2" H
• Mail slot: 11" W x 4" H

WEIGHT
10 lbs.

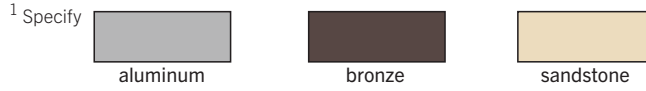
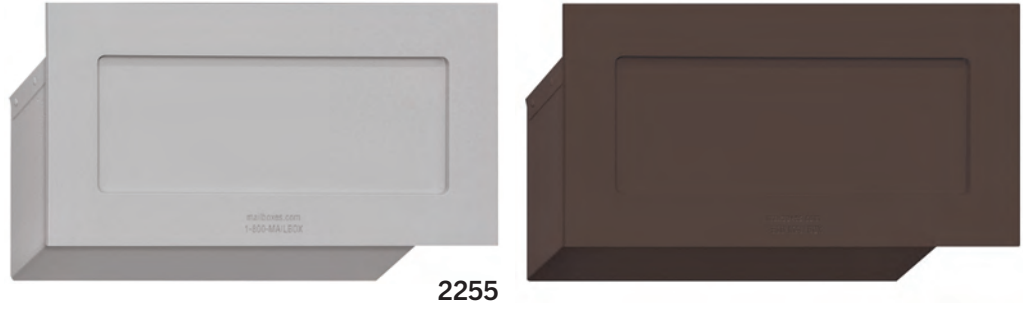

RECEPTACLES PRIVATE ACCESS

Made of sheet and extruded aluminum, Salsbury receptacles have a 12" W x 6" H rear opening which aligns with mail drops (#2255 - see above - order separately). Receptacles have heavy duty 1/4" thick aluminum doors and are accessed from the front. Receptacles include a lock with two (2) keys and feature a durable powder coated finish available in three (3) contemporary colors. Custom engraving (#2266), plexiglass windows (#2273) and thumb latches (#2288) are available as options upon request.

DESCRIPTION
2256¹ - Receptacle

UNIT SIZE
15" W x 19" H x 7-1/2" D
Rear opening: 12" W x 6" H

WEIGHT
20 lbs.



CUSTOM ENGRAVING
(OPTION - #2266)
Custom engraving (specify regular or black filled) is available as an option upon request.
Examples are: OUTGOING MAIL, MAIL, PAYMENTS, LETTERS, KEYS, SUGGESTION BOX, OFFICE, RENT DROP or as specified.

PLEXIGLASS WINDOW
(OPTION - #2273)
A 2" W x 10" H plexiglass window is available as an option upon request.

THUMB LATCH
(OPTION - #2288)
A non-locking thumb latch is available as an option upon request.

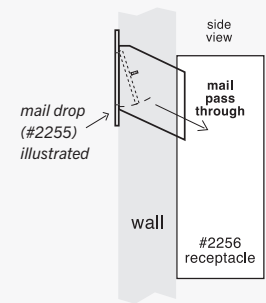

order mail drops and receptacles separately



#2256 receptacle with custom engraving - regular (#2266) and #2255 mail drop displayed

Courier Boxes

COURIER BOXES PRIVATE access

Made of 14 gauge steel, Salsbury courier boxes provide a convenient means of depositing and collecting mail, documents, small packages and other items. Courier boxes feature a durable powder coated finish available in three (3) contemporary colors (or primer). Each courier box user access door is equipped with a three (3) point locking mechanism with three (3) keys to protect its contents. Courier boxes can withstand severe weather conditions and are suitable when a secure environment is required. Courier boxes are ideal for colleges and schools, military bases, commercial buildings, libraries, government agencies, businesses and many other applications.

Current Pricing and Volume Discounts Available at Mailboxes.com!

Ideal for:

- *Colleges and Schools*
- *Commercial Buildings*
- *Government Agencies*
- *Military Bases*
- *Businesses*
- *Libraries*
- *Municipalities*
- *E-commerce Deliveries*
- *Homes and Residences*



custom
Numbers / Letters see mailboxes.com

#4975's in blue finish with optional custom engraved placards (#4967) displayed



4975



DESCRIPTION
4975¹ - Courier Box

UNIT SIZE
20" W x 49" H x 26" D

Package Drop Opening: 15-3/4" W x 7" H

Storage Area: 19" W x 28" H x 21" D

WEIGHT
160 lbs.

COURIER BOX TOP OPENING



Convenient depositing of items

COURIER BOX BOTTOM OPENING



Secure collection of items

COURIER BOX OPTIONS

4990 LOCK - STANDARD

- replacement - with (3) keys



4993 BASE MOUNTING KIT - EXPANSION WEDGE ANCHOR BOLTS

- For existing concrete installations
- (4) 1/2" W X 5-1/2" H wedge anchor bolts
- 2 lbs.

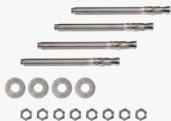

CUSTOM ENGRAVED PLACARDS

12" W x 2" H custom engraved self-adhesive placards are available as an option upon request. (#4967)

AFTER HOURS DROP

4994 BASE MOUNTING KIT - ANCHOR (J) BOLTS

- For new concrete installations
- (4) 1/2" W x 8" H anchor (J) bolts
- 2 lbs.

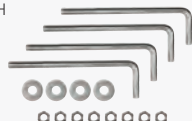

FRONT ACCESS ON #4975

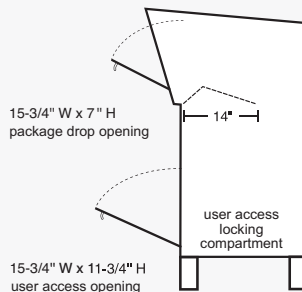

BASE BOLT PATTERN

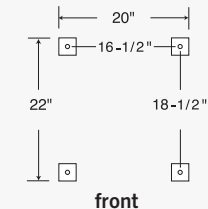

¹ Specify



gray



white



blue



primer

Mail Package Drops

MAIL PACKAGE DROPS U.S.P.S. APPROVED

Made entirely of aluminum, Salsbury U.S.P.S. approved 4300 series mail package drops feature both a front and rear access locking door. Mail is deposited through a non-locking access panel on the front. Each unit includes an outgoing mail tray, a lock with two (2) keys on each door (keyed alike) and an adjustable red signal flag. Units are available in a durable powder coated black, bronze, silver or white finish. Mail package drops can be mounted on the optional bolt mounted (#4395) or in-ground mounted (#4385) aluminum pedestals or a base of your choice. Non-locking thumb latches (#4388) are available as an option upon request. Mail package drops are approved for U.S.P.S. curbside mail delivery. Master postal lock not required.

Current Pricing and Volume Discounts Available at Mailboxes.com!



Front view of #4375 displayed



Rear view of #4375 displayed

ALL ALUMINUM
CONSTRUCTION

custom
Numbers / Letters see mailboxes.com

**FRONT AND
REAR ACCESS
ON #4375**

11" W x 4" H
outgoing mail tray

11" W x 5" H
mail deposit

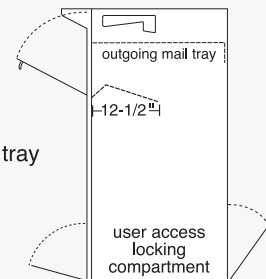

**Locking
Mailboxes**

#4375's attached to bolt mounted pedestals (#4395) with optional custom numbers / letters (see mailboxes.com) displayed



4375

bolt mounted pedestal #4395

in-ground mounted pedestal #4385

DESCRIPTION

4375¹ - Mail Package Drop
Front and rear access

UNIT SIZE

14-3/8" W x 36" H x 23" D

WEIGHT

50 lbs.

PEDESTALS

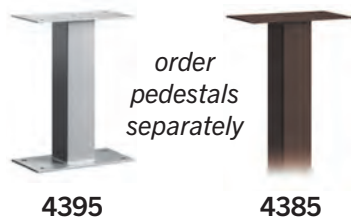

order pedestals separately

4395

4385

PEDESTAL BOLT PATTERNS

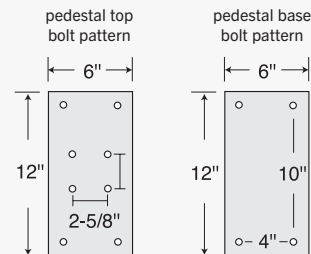

MAIL PACKAGE DROP PEDESTALS & OPTIONS

MODEL	DESCRIPTION	UNIT SIZE	WEIGHT
4395 ¹	Pedestal - bolt mounted	3-1/2" W x 16" H x 3-1/2" D	10 lbs.
4385 ¹	Pedestal - in-ground mounted	3-1/2" W x 48" H x 3-1/2" D	20 lbs.
4390	Lock set - (2) standard replacement locks (keyed alike) - with (2) keys each		
4393	Pedestal mounting kit - (4) expansion wedge anchor bolts - for existing concrete		2 lbs.
4394	Pedestal mounting kit - (4) anchor (J) bolts - for new concrete		2 lbs.
4316	Replacement flag	2-3/4" W x 8" H x 1/4" D	

CUSTOM ENGRAVED PLACARDS

8-1/2" W x 2" H custom engraved self-adhesive placards are available as an option upon request. (#4367)



THUMB LATCH

A non-locking thumb latch is available as an option upon request. (#4388)



¹ Specify



Mail Chests

MAIL CHESTS U.S.P.S. APPROVED

Made entirely of aluminum, Salsbury U.S.P.S. approved 4300 series mail chests feature both a front and rear access locking door. Mail is deposited through a non-locking access panel on the front. Each unit includes an outgoing mail tray, a lock with two (2) keys on each door (keyed alike) and an adjustable red signal flag. Units are available in a durable powder coated black, bronze, silver or white finish. Mail chests can be mounted on the optional bolt mounted (#4365) or in-ground mounted (#4385) aluminum pedestals or a base of your choice. Mail chests can also be mounted in columns, masonry or walls. Non-locking thumb latches (#4388) are available as options upon request. Mail chests are approved for U.S.P.S. curbside mail delivery. Master postal lock not required. For a smaller version of this product, see roadside mailboxes on pages 52-53.

**Current Pricing and Volume Discounts
Available at Mailboxes.com!**



#4350's on a three (3) wide spreader (#4383) attached to a bolt mounted pedestal (#4365) with optional custom numbers / letters (see mailboxes.com) displayed



Rear view of #4350 mounted in a column displayed

FRONT AND REAR ACCESS ON #4350

11" W x 2-3/4" H
outgoing mail tray

11" W x 2" H
mail deposit

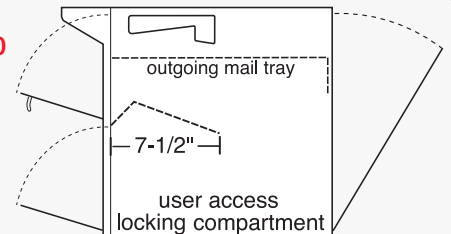

SPREADERS

Made of heavy duty aluminum, Salsbury spreaders are an ideal way to mount multiple mail chests to pedestals. Optional two (2) wide (#4382) and three (3) wide (#4383) spreaders easily attach to standard pedestals (#4365 and #4385).

#4382 on a pedestal (#4365) displayed

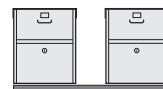

#4382 (2) wide spreader



#4383 (3) wide spreader



4350

*bolt mounted
pedestal #4365*



*in-ground mounted
pedestal #4385*



DESCRIPTION

4350¹ - Mail Chest
Front and rear access

UNIT SIZE

14-3/8" W x 17-1/4" H x 23" D

WEIGHT

30 lbs.

PEDESTALS



PEDESTAL BOLT PATTERNS

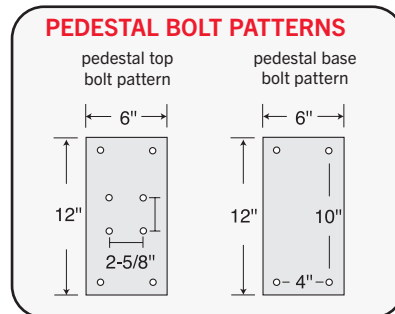

MAIL CHEST PEDESTALS & OPTIONS

MODEL	DESCRIPTION	UNIT SIZE	WEIGHT
4365 ¹	Pedestal - bolt mounted	3-1/2" W x 32" H x 3-1/2" D top & base: 6" W x 12" D	15 lbs.
4385 ¹	Pedestal - in-ground mounted	3-1/2" W x 48" H x 3-1/2" D top: 6" W x 12" D	20 lbs.
4382 ¹	Spreader - 2 wide	34" W x 9" D	10 lbs.
4383 ¹	Spreader - 3 wide	55" W x 9" D	15 lbs.
4390	Lock set - (2) standard replacement locks (keyed alike) - with (2) keys each		
4393	Pedestal mounting kit - (4) expansion wedge anchor bolts - for existing concrete		2 lbs.
4394	Pedestal mounting kit - (4) anchor (J) bolts - for new concrete		2 lbs.
4316	Replacement flag	2-3/4" W x 8" H x 1/4" D	

CUSTOM ENGRAVED PLACARDS

8-1/2" W x 2" H custom engraved self-adhesive placards are available as an option upon request. (#4367)



THUMB LATCH

A non-locking thumb latch is available as an option upon request. (#4388)



¹ Specify

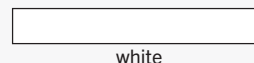
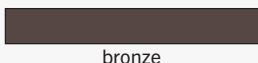
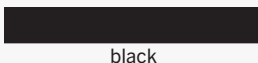

Mailbox Locks & Key Blanks

UNIVERSAL MAILBOX REPLACEMENT LOCKS

Each universal mailbox replacement lock includes at least five (5) separate interchangeable cams to adapt to various mailbox manufacturers' door locks.

Items #1190 and #1195 include two (2) keys and three (3) keys, respectively and (100) different key changes.

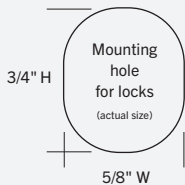

1190-5 - Universal Locks

- set of five (5) #1190 locks
- for 4B+ Horizontal and Vertical styles
- nut mounted with two (2) keys

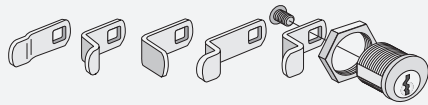

1195-5 - Universal Locks

- set of five (5) #1195 locks
- for CBU E-series and NDCBU pedestal styles
- clip mounted with (3) keys

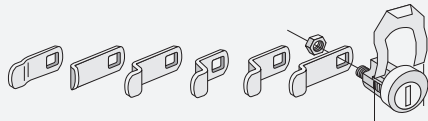

UNIVERSAL KEY BLANKS

1199 - Universal Key Blanks

- for universal locks
- Box of (50)



CLUSTER BOX UNITS / OPL's

Pages 8-15



3316 displayed

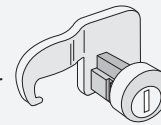

- ### 3390-5 - Tenant Door Locks
- set of five (5) #3390 locks
 - for 3300 F series CBU's
 - with three (3) keys

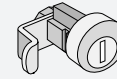

- ### 3390E-5 - Tenant Door Locks
- set of five (5) #3390E locks
 - for 3300 E series CBU's
 - with three (3) keys

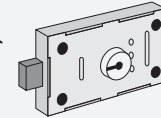

- ### 3375 - Master Commercial Lock
- for private access to master door and parcel locker door
 - with two (2) keys
 - private access only

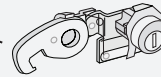

- ### 3376 - Tenant Parcel Locker Lock
- for parcel locker door
 - with three (3) keys



- ### 3377 - Tenant Parcel Lock Cylinder
- for outdoor parcel locker door
 - with three (3) keys

4C HORIZONTAL MAILBOXES

Pages 16-31



3716D-15 displayed

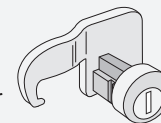

- ### 3790-5 - Tenant Door Locks
- set of five (5) #3790 locks
 - for 3700 series 4C Horizontal mailboxes
 - with three (3) keys



- ### 3799 - Box of (50) Key Blanks

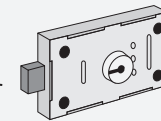

- ### 3775 - Master Commercial Lock
- for private access to master door and parcel locker door
 - with two (2) keys
 - private access only

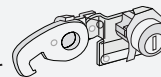

- ### 3776 - Tenant Parcel Locker Lock
- for parcel locker door
 - with three (3) keys

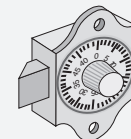

- ### 3786 - Tenant Combination Lock
- for 3700 series 4C Horizontal mailboxes
 - private access only

4B+ HORIZONTAL MAILBOXES

Pages 32-33

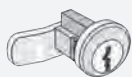

- 3690-5 - Tenant Door Locks**
- set of five (5) #3690 locks
 - for 3600 series
 - 4B+ Horizontal mailboxes
 - with two (2) keys



- 3699 - Box of (50) Key Blanks**

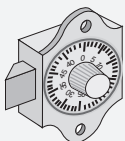

- 3686 - Tenant Combination Lock**
- for 3600 series
 - 4B+ Horizontal mailboxes
 - private access only

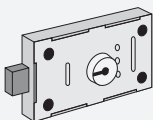

- 3675 - Master Commercial Lock**
- for private access to master door and parcel locker door
 - with two (2) keys
 - private access only



- 3676 - Tenant Parcel Locker Lock**
- includes lock assembly
 - with two (2) keys

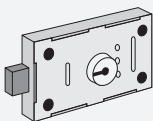

- 3677 - Master Commercial Lock**
- for private access to 4B+ collection unit
 - with two (2) keys
 - private access only



- 3682 - Resettable Combination Lock**
- for 3600 series
 - 4B+ Horizontal mailboxes
 - private access only



- 3683 - Master Control Key**
- for 3682 resettable combination lock



- 3689 - Thumb Latch**
- for 3600 series
 - 4B+ Horizontal mailboxes
 - private access only

VERTICAL MAILBOXES

Pages 34-35

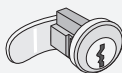

- 3590-5 - Tenant Door Locks**
- set of five (5) #3590 locks
 - for 3500 series
 - Vertical mailboxes
 - with two (2) keys



- 3599 - Box of (50) Key Blanks**



- 3575 - Master Commercial Lock**
- for private access to master door
 - with two (2) keys
 - private access only

KEY KEEPERS

Page 34

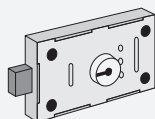

- 1095 - Commercial Lock**
- for private access to 1080 and 1090
 - with two (2) keys
 - private access only

ALUMINUM MAILBOXES

Pages 36-39

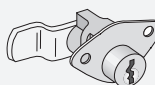

- 2290-5 - Tenant Door Locks**
- set of five (5) #2290 locks
 - for 2200 series
 - Aluminum mailboxes
 - with two (2) keys



- 2298 - Additional Key**
- for 2290-5

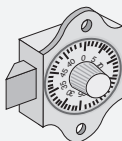

- 2286 - Tenant Combination Lock**
- for 2200 series
 - Aluminum mailboxes



- 2276 - Tenant Parcel Locker Lock**
- for 2270 & 2272
 - Parcel Lockers
 - includes assembly
 - with two (2) keys

ALUMINUM MAILBOXES

Pages 36-39



- 2299 - Box of (50) Key Blanks**

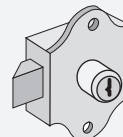

- 2287 - Tenant Spring Latch Lock**
- for 2200 series
 - Aluminum mailboxes
 - with two (2) keys

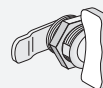

- 2289 - Thumb Latch**
- for 2200 series
 - Aluminum mailboxes

LETTER BOXES / RECEPTACLES

Pages 40-41

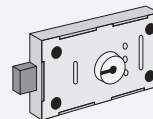

- 2246 - Commercial Lock**
- for private access to 2240, 2245, 2256, 2260 and 2265
 - with two (2) keys
 - private access only

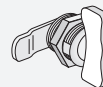

- 2288 - Thumb Latch**
- for 2240, 2245, 2256, 2260 and 2265
 - private access only

COURIER BOXES

Pages 44-45



- 4990 - Lock**
- for 4975
 - with three (3) keys

MAIL PACKAGE DROPS / MAIL CHESTS

Pages 46-49

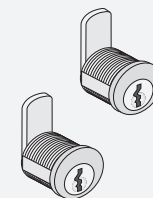

- 4390 - Lock Set**
- for 4375 and 4350
 - set of (2) - keyed alike
 - with two (2) keys each

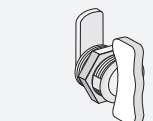

- 4388 - Thumb Latch**
- for 4375 and 4350

Roadside Mailboxes

ROADSIDE MAILBOXES

U.S.P.S. APPROVED

Made entirely of aluminum, Salsbury U.S.P.S. approved 4300 series roadside mailboxes feature both a front and rear access locking door. Available in a durable powder coated black, bronze, silver or white finish, each unit includes an outgoing mail tray, a lock with two (2) keys on each door (keyed alike) and an adjustable red signal flag. Mail is deposited through a non-locking access panel on the front. Roadside mailboxes can be mounted on the optional bolt mounted (#4365) or in-ground mounted (#4385) aluminum pedestals, in-ground mounted aluminum deluxe posts (#4370, #4372, #4373 and #4374) or a base of your choice. Roadside mailboxes can also be mounted in columns, masonry or walls. Non-locking thumb latches (#4388) are available as options upon request. Roadside mailboxes are approved for U.S.P.S. curbside mail delivery. Master postal lock not required. For a larger version of this product, see mail chests on pages 48-49.

Current Pricing and Volume Discounts Available at Mailboxes.com!



Front view of #4325 mounted in a column with optional custom numbers / letters (see mailboxes.com) displayed

FRONT AND REAR ACCESS ON #4325

10" W x 1-3/4" H outgoing mail tray

10" W x 1-3/4" H mail deposit

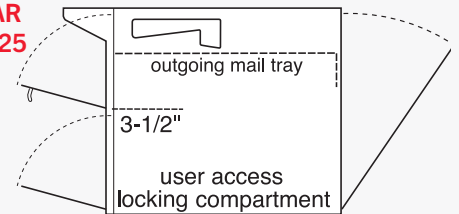

SPREADERS

Made of heavy duty aluminum, Salsbury spreaders are an ideal way to mount multiple roadside mailboxes to pedestals. Optional two (2) wide (#4382), three (3) wide (#4383) and four (4) wide (#4384) spreaders easily attach to standard pedestals (#4365 and #4385).

#4382 on a pedestal (#4365) displayed



#4382 two (2) wide spreader



#4383 three (3) wide spreader



#4384 four (4) wide spreader (includes two (2) support arms)

Locking Mailboxes

#4325's on a three (3) wide spreader (#4383) attached to an in-ground mounted pedestal (#4385) with optional custom numbers / letters (see mailboxes.com) displayed



DESCRIPTION

4325¹ - Roadside Mailbox

UNIT SIZE

12-1/2" W x 13-5/8" H x 18-1/4" D

WEIGHT

25 lbs.

PEDESTALS

order pedestals separately

4365 **4385**

BOLT PATTERNS

PEDESTALS

pedestal top bolt pattern: 6" wide, 12" high, 2-5/8" spacing

pedestal base bolt pattern: 6" wide, 12" high, 10" high, 0-4" spacing

DELUXE POSTS

post arm bolt pattern for one mailbox: 3-1/2" high, 14" wide, 2-5/8" spacing

post arm bolt pattern for two (2) mailboxes: 3-1/2" high, 28-3/4" wide, 2-5/8" spacing

ROADSIDE MAILBOX PEDESTALS, POSTS & OPTIONS

MODEL	DESCRIPTION	UNIT SIZE	WEIGHT
4365 ¹	Pedestal - bolt mounted	3-1/2" W x 32" H x 3-1/2" D	15 lbs.
4385 ¹	Pedestal - in-ground mounted	3-1/2" W x 48" H x 3-1/2" D	20 lbs.
4370 ¹	Deluxe Post - for (1) roadside mailbox	25" W x 81" H x 4" D	35 lbs.
4372 ¹	Deluxe Post - for (2) roadside mailboxes	35" W x 81" H x 4" D	45 lbs.
4373 ¹	Deluxe Post - for (3) roadside mailboxes	49" W x 81" H x 4" D	55 lbs.
4374 ¹	Deluxe Post - for (4) roadside mailboxes	63" W x 81" H x 4" D	65 lbs.
4382 ¹	Spreader - 2 wide	34" W x 9" D	10 lbs.
4383 ¹	Spreader - 3 wide	55" W x 9" D	15 lbs.
4384 ¹	Spreader - 4 wide (includes 2 support arms)	63-1/2" W x 9" D	35 lbs.
4316	Replacement flag	2-3/4" W x 8" H x 1/4" D	1 lb.
4393	Pedestal mounting kit - (4) expansion wedge anchor bolts - for existing concrete		2 lbs.
4394	Pedestal mounting kit - (4) anchor (J) bolts - for new concrete		2 lbs.
4390	Lock set - (2) standard replacement locks (keyed alike) - with (2) keys each		

CUSTOM ENGRAVED PLACARDS

8-1/2" W x 2" H custom engraved self-adhesive placards are available as an option upon request. (#4367)



THUMB LATCH

A non-locking thumb latch is available as an option upon request. (#4388)



¹ Specify

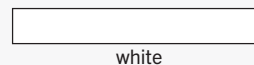
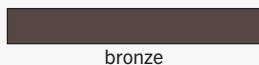

Heavy Duty Rural Mailboxes

HEAVY DUTY RURAL MAILBOXES U.S.P.S. APPROVED

Made entirely of aluminum, Salsbury U.S.P.S. approved 4800 series heavy duty rural mailboxes feature a 1/8" thick extruded aluminum body and a 1/8" thick die cast aluminum front door and rear cover. Heavy duty rural mailboxes also feature a durable powder coated finish available in four (4) contemporary colors and include an adjustable red signal flag and a magnetic door catch. The die cast door is attached to the body with a full width stainless steel hinge allowing for smooth operation. Heavy duty rural mailboxes can be mounted on standard or deluxe mailbox posts (see pages 56-59), spreaders (see page 57) or a base of your choice. Rural mailboxes are approved for U.S.P.S. curbside mail delivery.

**Current Pricing and Volume Discounts
Available at Mailboxes.com!**



Custom
Numbers / Letters see mailboxes.com

#4850 on a standard post
(#4895 - see page 56) with
optional custom numbers / letters
(see mailboxes.com) displayed



#4850 on a deluxe post
(#4872 - see page 59) with
optional custom numbers / letters
(see mailboxes.com) displayed



#4850 in a brick column displayed

REPLACEMENT FLAGS

Made of heavy duty 1/4" thick die cast aluminum, rural mailbox replacement signal flags have a durable powder coated red finish and easily attach to heavy duty rural mailboxes. Mailbox flags include stainless steel mounting hardware.

- 4816 - Replacement Flag**
- 2-3/4" W x 8" H x 1/4" D
 - 1 lb.



4816

HEAVY DUTY RURAL MAILBOXES



4850

DESCRIPTION
4850¹ - Rural Mailbox

UNIT SIZE
7-1/2" W x 9-1/2" H x 20-1/2" D

WEIGHT
15 lbs.

¹ Specify



Flag

heavy duty 1/4" thick die cast aluminum signal flag with stainless steel mounting hardware

Finish

mailbox exterior and interior feature a durable powder coated finish

Catch

secure magnetic catch

Reinforcement

ridges formed along the length of the unit provide added strength

Weather-proofing

an interior rib prevents water from entering the mailbox

Handle

ergonomically designed oversized handle

Door

heavy duty die cast aluminum door

Hinge

concealed heavy duty full width stainless steel hinge

Strength

heavy duty U.S.P.S. approved mailboxes are made of 1/8" thick die cast and extruded aluminum



#4850 displayed

Standard Mailbox Posts & Spreaders

STANDARD MAILBOX POSTS & SPREADERS FOR RURAL MAILBOXES

Made of heavy duty aluminum, Salsbury standard mailbox posts accommodate rural mailboxes (see pages 54-55) and are available in a bolt mounted style (#4865) and an in-ground mounted style (#4895). Salsbury spreaders are an ideal way to mount multiple rural mailboxes to mailbox posts. Available in four (4) widths, mailbox spreaders include mounting hardware to easily attach to standard mailbox posts. Standard mailbox posts and spreaders feature a durable powder coated finish available in four (4) contemporary colors.

Current Pricing and Volume Discounts Available at Mailboxes.com!



Standard post (#4895) with rural mailbox (#4850) and optional custom numbers / letters (see mailboxes.com) displayed

Order rural mailboxes (see pages 54-55) separately

DESCRIPTION

4865¹ - Standard Post - Bolt mounted

UNIT SIZE

Post: 3-1/2" W x 42" H x 3-1/2" D
Top & base: 6" W x 12" D

WEIGHT

20 lbs.

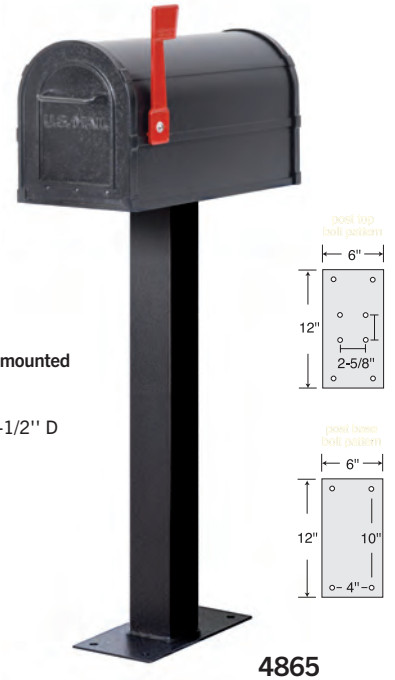

4865

DESCRIPTION

4895¹ - Standard Post - In-ground mounted

UNIT SIZE

Post: 3-1/2" W x 60" H x 3-1/2" D
Top: 6" W x 12" D

WEIGHT

25 lbs.



4895



¹ Specify



black



bronze



sandstone

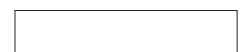

white



Standard post (#4895) with rural mailboxes (#4850) on three (3) wide spreader (#4883) and optional custom numbers / letters (see mailboxes.com) displayed

MAILBOX SPREADERS



DESCRIPTION

4882¹ - Spreader - 2 wide

UNIT SIZE
19" W x 7-1/4" D

WEIGHT
10 lbs.



DESCRIPTION

4883¹ - Spreader - 3 wide

UNIT SIZE
34" W x 7-1/4" D

WEIGHT
15 lbs.



DESCRIPTION

4884¹ - Spreader - 4 wide

UNIT SIZE
50" W x 7-1/4" D

WEIGHT
20 lbs.



DESCRIPTION

4885¹ - Spreader - 5 wide
Includes two (2) support arms

UNIT SIZE
55" W x 7-1/4" D

WEIGHT
30 lbs.



Standard post (#4865) with rural mailboxes (#4850) on two (2) wide spreader (#4882) and optional custom numbers / letters (see mailboxes.com) displayed

¹ Specify

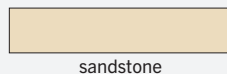
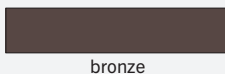
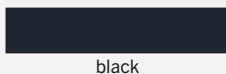

Deluxe Mailbox Posts

DELUXE MAILBOX POSTS FOR RURAL MAILBOXES

Made of heavy duty aluminum, Salsbury in-ground mounted deluxe mailbox posts feature a durable powder coated finish available in four (4) attractive colors. Deluxe mailbox posts can accommodate rural mailboxes (see pages 54-55). The arms of the deluxe posts measure 3-1/2" D and 3-1/2" H. Deluxe posts for one mailbox (#4870) include a 14" wide arm and can be assembled with the mailbox mounted on either the right side or the left side. Deluxe posts for two (2) mailboxes (#4872) include two (2) 14" wide arms. Deluxe posts for three (3) mailboxes (#4873) include one 14" wide arm and one 23" wide arm. Deluxe posts for four (4) mailboxes (#4874) include two (2) 23" wide arms. Deluxe posts for five (5) mailboxes (#4875) include two (2) 14" wide arms and one 36-1/2" wide center bridge. Minor assembly is required.

Current Pricing and Volume Discounts Available at Mailboxes.com!



Deluxe post (#4870) with rural mailboxes #4850 (see pages 54-55) and optional custom numbers / letters (see mailboxes.com) displayed

Post arm bolt pattern for one mailbox

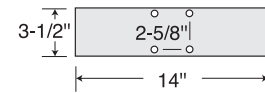

Post arm bolt pattern for two (2) mailboxes

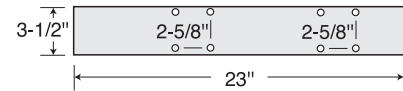

Post bolt pattern for center bridge for three (3) mailboxes on #4875

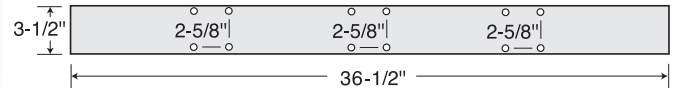

Order rural mailboxes (see pages 54-55) separately

Deluxe post (#4874) with four (4) rural mailboxes #4850 (see pages 54-55) and optional custom numbers / letters (see mailboxes.com) displayed



DESCRIPTION
 4870¹ - Deluxe Post -
 1-sided for
 one (1) mailbox
 in-ground mounted

UNIT SIZE

Post:
 25" W x 81" H x 4" D

WEIGHT

35 lbs.



DESCRIPTION
 4872¹ - Deluxe Post -
 2-sided for
 two (2) mailboxes
 in-ground mounted

UNIT SIZE

Post:
 35" W x 81" H x 4" D

WEIGHT

45 lbs.



DESCRIPTION
 4873¹ - Deluxe Post -
 2-sided for
 three (3) mailboxes
 in-ground mounted

UNIT SIZE

Post:
 45" W x 81" H x 4" D

WEIGHT

55 lbs.

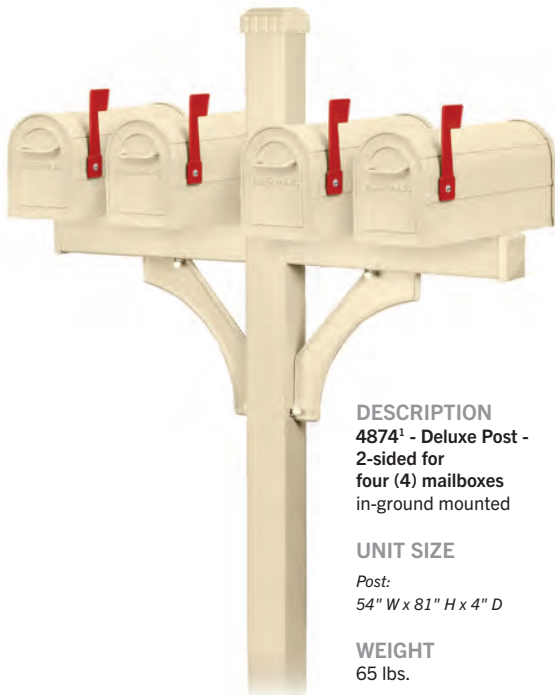

DESCRIPTION
 4874¹ - Deluxe Post -
 2-sided for
 four (4) mailboxes
 in-ground mounted

UNIT SIZE

Post:
 54" W x 81" H x 4" D

WEIGHT

65 lbs.



DESCRIPTION
 4875¹ - Deluxe Post -
 Bridge Style for
 five (5) mailboxes
 in-ground mounted

UNIT SIZE

Posts:
 76" W x 81" H x 4" D

WEIGHT

95 lbs.

Note - Order mailboxes separately

¹ Specify



black



bronze



sandstone



white

Cell Phone Lockers

continued on pages 61-62

CELL PHONE LOCKERS

Made entirely of aluminum, Salsbury 19100 series cell phone lockers with front access panels are ideal for use in health clubs, government facilities, office buildings, schools and other settings where small personal items need to be stored safely and securely. Cell phone lockers can be surface mounted or recessed mounted and accommodate cell phones, tablet PC's, wallets, cameras, keys and other small valuable items. Cell phone lockers come in seven (7) door and five (5) door high units and feature a durable powder coated finish available in three (3) contemporary colors. Cell phone lockers come in configurations with standard A doors (6-1/2" W x 5-1/4" H) and larger B doors (13" W x 5-1/4" H) and each cell phone locker door includes a 2" W x 5/8" H clear plastic cardholder (card included) to identify the compartment. Cell phone locker compartments are 8" deep and feature master keyed locks or resettable combination locks. Master keyed locks include three (3) keys and allow access to all compartments with a master control key (#19991). Resettable combination locks can be set to a fixed combination or a combination that can be reset after each use. Custom engraved placards (#19967) and custom door engraving (#19968 - regular and #19962 - black filled) are available as options upon request. See cell phone locker options and locks on page 62.

CELL PHONE LOCKER SAMPLE INSTALLATIONS

SURFACE MOUNTED

Model displayed:
(1) 19178-35

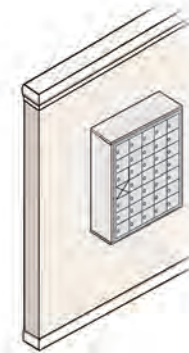

surface mounted

Surface mounted units mount directly to a flat surface and are secured with mounting hardware (not included) through the back panel.

RECESSED MOUNTED

Model displayed:
(1) 19178-35

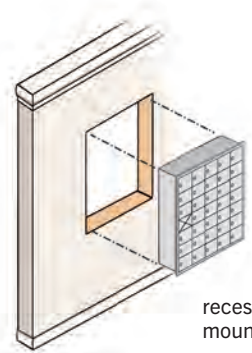

recessed mounted

Recessed mounted units fit into a rough opening and are secured with mounting hardware (not included) through the back or side panels. Recessed mounted units feature a fully integrated flanged collar which fits over the rough opening.

**Current Pricing
Available at [Lockers.com!](http://Lockers.com)**

Note: The rough opening for recessed mounted cell phone lockers is 2-1/4" less than the surface mounted unit's width, 2-1/4" less than the unit's height and equal to the unit's depth.



#19158-25's - surface mounted units with resettable combination locks displayed

Ideal for:

- Health Clubs
- Military Bases
- Schools and Universities
- Employee Breakrooms
- High Security Locations
- Government Facilities



7 DOOR HIGH CELL PHONE LOCKERS



19178-21

Surface mounted unit with master keyed locks displayed



19178-28

Surface mounted unit with resettable combination locks displayed



19178-35

Surface mounted unit with master keyed locks displayed



19178-24

Surface mounted unit with resettable combination locks displayed

CELL PHONE LOCKERS - SEVEN DOORS HIGH - WITH FRONT ACCESS PANEL

MODEL	DESCRIPTION	UNIT SIZE	WEIGHT
7 DOOR HIGH UNITS (surface mounted: 9-1/4" D recessed mounted: 8-3/4" D)			
19178-21 ^{1,2,3}	21 A Doors (20 usable)	24" W x 42" H	80 lbs.
19178-28 ^{1,2,3}	28 A Doors (27 usable)	30-1/2" W x 42" H	95 lbs.
19178-35 ^{1,2,3}	35 A Doors (34 usable)	37" W x 42" H	110 lbs.
19178-24 ^{1,2,3}	20 A Doors (19 usable), 4 B Doors	30-1/2" W x 42" H	95 lbs.

STANDARD CONFIGURATIONS

7 DOOR HIGH UNITS - 42" H

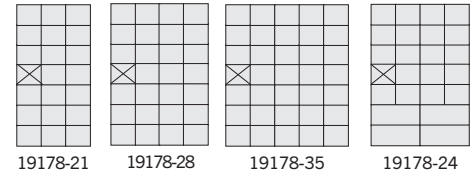

5 DOOR HIGH CELL PHONE LOCKERS



19158-15

Surface mounted unit with resettable combination locks displayed



19158-20

Surface mounted unit with master keyed locks displayed



19158-25

Surface mounted unit with resettable combination locks displayed



19158-16

Surface mounted unit with master keyed locks displayed

CELL PHONE LOCKERS - FIVE DOORS HIGH - WITH FRONT ACCESS PANEL

MODEL	DESCRIPTION	UNIT SIZE	WEIGHT
5 DOOR HIGH UNITS (surface mounted: 9-1/4" D recessed mounted: 8-3/4" D)			
19158-15 ^{1,2,3}	15 A Doors (14 usable)	24" W x 31" H	60 lbs.
19158-20 ^{1,2,3}	20 A Doors (19 usable)	30-1/2" W x 31" H	75 lbs.
19158-25 ^{1,2,3}	25 A Doors (24 usable)	37" W x 31" H	80 lbs.
19158-16 ^{1,2,3}	12 A Doors (11 usable), 4 B Doors	30-1/2" W x 31" H	75 lbs.

STANDARD CONFIGURATIONS

5 DOOR HIGH UNITS - 31" H

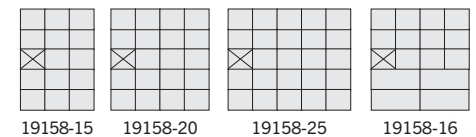

¹ Specify



² Specify - surface or recessed mounted

³ Specify - master keyed locks or resettable combination locks

⊗ Note: The front access panel swings on a continuous hinge. One compartment is required for a panel lock (included) and cannot be used for cell phone storage. For multiple unit installations, all front access panel locks are keyed alike.

see cell phone locker enclosures and options on page 62

Cell Phone Locker Options & Locks

STANDARD FEATURES

Each cell phone locker features plastic card holders for door identification and either master keyed locks or resettable combination locks.

PLASTIC CARD HOLDER

- Replacement clear plastic card holder 2" W x 5/8" H (#19997)

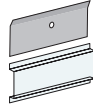

FRONT ACCESS PANEL LOCK

- Front access panel replacement lock - with (2) keys. (#19177)

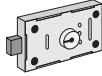

CUSTOM DOOR IDENTIFICATION

- Custom engraved placard (#19967)
- Custom engraved door - regular (door will be solid - no card holder) (#19968)
- Custom engraved door - black filled (door will be solid - no card holder) (#19962)



CUSTOM FINISH

Custom finishes (#19966) are available as an option upon request. Minimum order of ten (10) units.



CUSTOM CONFIGURATIONS

- Custom door configurations
- Removable rear cover access panels
- Minimum order of ten (10) units.

DOORS

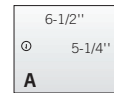

Replacement "A" door and master keyed lock (#19951K)

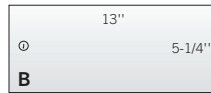

Replacement "B" door and master keyed lock (#19952K)



Plexiglass window 1-1/8" W x 7/8" H (#19971)

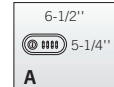

Replacement "A" door and resettable combination lock (#19951C)



Replacement "B" door and resettable combination lock (#19952C)



Door slot A and C Doors - 5-1/2" W x 3/4" H B and D Doors - 12" W x 3/4" H (#19969)

MASTER KEYED LOCK

- Master keyed replacement lock - with (3) keys (#19990)
- Master control key for 19990 (#19991)
- Additional key per lock when ordering (#19998)
- Key blanks - box of (50) (#19999)

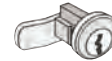

All master keyed locks can be accessed with a master control key.

RESETTABLE COMBINATION LOCK

- Resettable combination replacement lock (#19986)
 - Master control key (#19987)
- All resettable combination locks can be set to a fixed combination or a combination that can be reset after each use and can be accessed with a master control key.

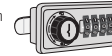

ALTERNATE LOCKING SYSTEMS - FACTORY INSTALLED

- Built-in spring latch combination lock (#19910)
- Master control key for 19910 (#19911)
- Built-in spring latch key lock (#19915)
- Master control key for 19915 (#19916)
- Combination padlock with built-in hasp (#19920)
- Master control key for 19920 (#19921)
- Key padlock with built-in hasp (#19925)
- Built-in hasp for user provided padlock (#19923)



ACCESSORIES

- Locker key wristband (#19992)
- Flexible grommet - 1" diameter - for device charging cables - factory installed in rear of compartment (#19960)
- Pedestals for select surface mounted cell phone lockers are available online



CELL PHONE LOCKER ENCLOSURES - FREE-STANDING

MODEL	DESCRIPTION	UNIT SIZE	WEIGHT
FOR 7 DOOR HIGH RECESSED MOUNTED CELL PHONE LOCKERS			
19973 ¹	Free-Standing enclosure for #19178-21	24" W x 66-1/2" H x 9-1/4" D	75 lbs.
19974 ¹	Free-Standing enclosure for #19178-28 and #19178-24	30-1/2" W x 66-1/2" H x 9-1/4" D	80 lbs.
19975 ¹	Free-Standing enclosure for #19178-35	37" W x 66-1/2" H x 9-1/4" D	85 lbs.
FOR 5 DOOR HIGH RECESSED MOUNTED CELL PHONE LOCKERS			
19953 ¹	Free-Standing enclosure for #19158-15	24" W x 61" H x 9-1/4" D	70 lbs.
19954 ¹	Free-Standing enclosure for #19158-16 and #19158-20	30-1/2" W x 61" H x 9-1/4" D	75 lbs.
19955 ¹	Free-Standing enclosure for #19158-25	37" W x 61" H x 9-1/4" D	80 lbs.



19953



19954



19955

¹ Specify

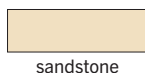
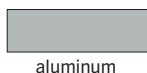

#19955 free-standing cell phone locker enclosure with recessed mounted cell phone lockers (#19158-25 - see page 61)

Note: It is recommended that all free-standing enclosures be wall and/or floor anchored.

Quality Lockers from Salsbury Industries!

Lockers - Metal, Wood & Plastic



Salsbury Industries is the industry leader in providing quality lockers to schools, health clubs, pool areas, employee rooms, gyms, country clubs, government facilities and many other applications. Our products include metal lockers, premier lockers, designer lockers, plastic lockers, locker benches and cell phone lockers. Most are available for immediate shipment. To request a free locker catalog, please call 1-800-562-5377 or visit us at lockers.com. To request a free locker quotation, email us at quotes@lockers.com.



The Industry Leader in **MAILBOXES**

mailboxes.com
1-800-MAILBOX



Contact Us for Large Quotes!



SALSBUURY
INDUSTRIES

People Committed to Quality Since 1936®

18300 Central Avenue
Carson, CA 90746-4008

phone: 1.800.624.5269
fax: 1.800.624.5299

phone: 1.323.846.6700
fax: 1.323.846.6800

email: salsbury@mailboxes.com
website: www.mailboxes.com